

1.

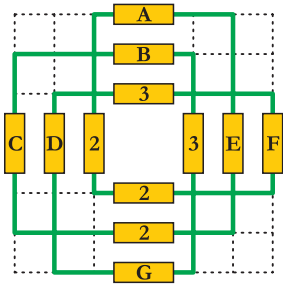

2.

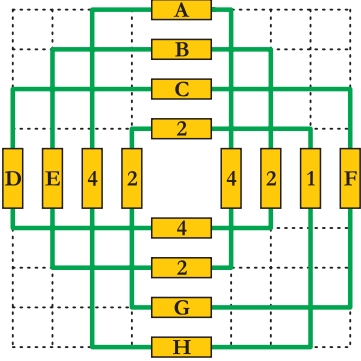

3.

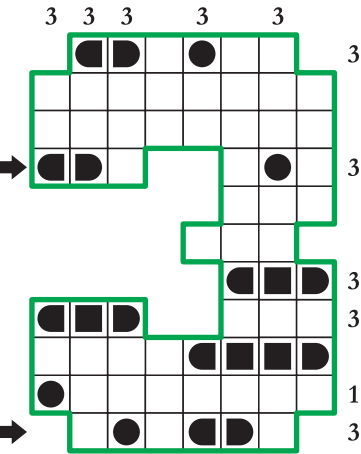

4.

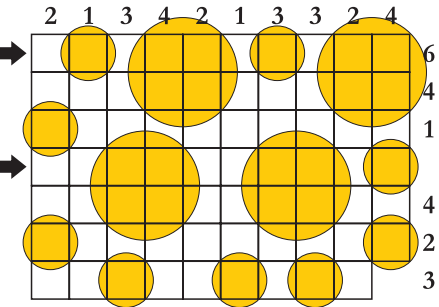

5.

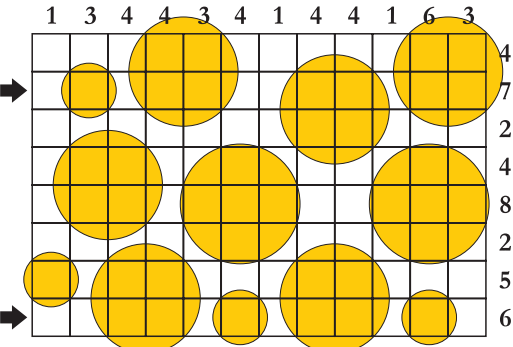

6.

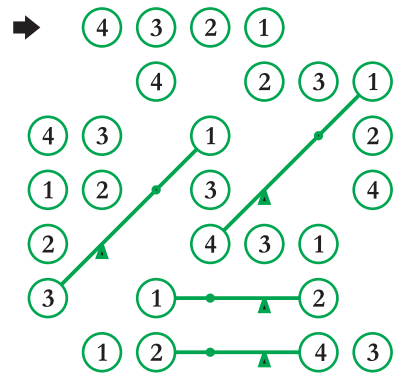

7.

	B						
→ A			D	B	C		
→ B	A		C	D			
D		D	A		B	C	
C			C	B		A	D
C	C	B	A		D		D
D	D	B			C		A
D	D	C			A		B
	B	B		D	B		

8.

		D	C		
→ A		D	B	C	A
C	C		D	B	A
→ B	B	A	C		D
→ D		C	A	D	B
	D	B		A	C
				A	A

9.

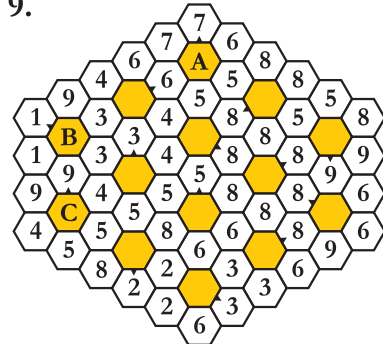

10.

