

Round 1: Familiar Foes

Yinyang
(Priyam Bhushan)

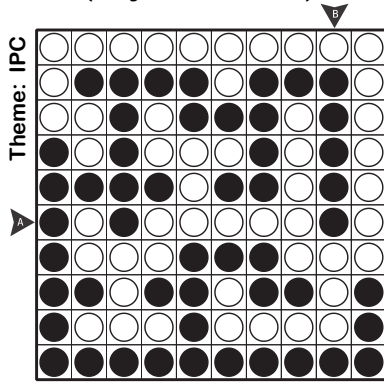

Tents
(Walker Anderson)

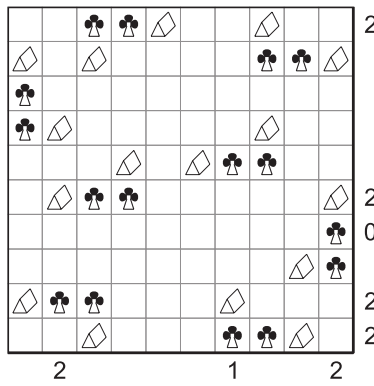

Battleships
(Rakesh Rai)

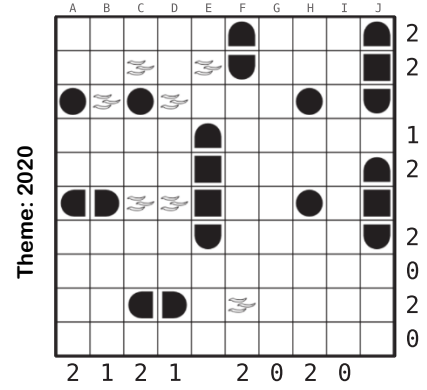

Nurikabe
(Ivan Koswara)

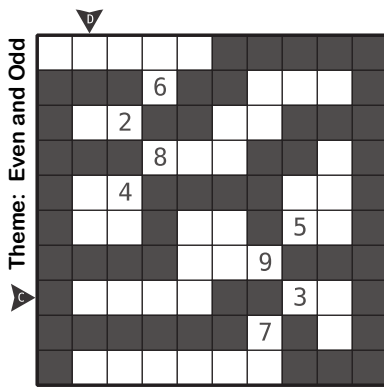

Yajilin
(Walker Anderson)

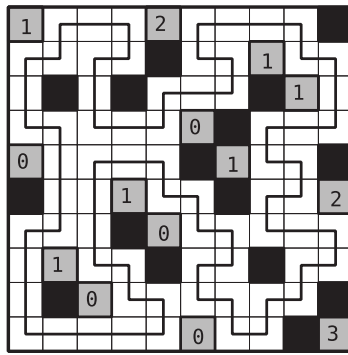

Rassi Silai
(Priyam Bhushan)

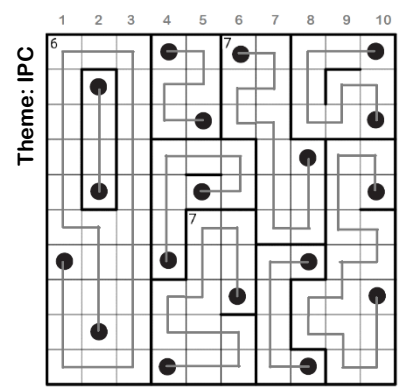

Ripple Effect
(Walker Anderson)

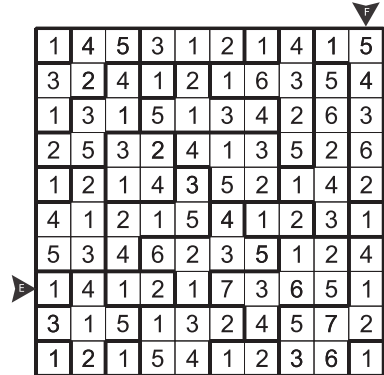

Pentominous
(Ivan Koswara)

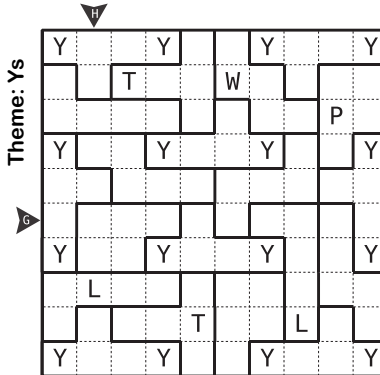

Kakuro
(Čedomir Milanović)

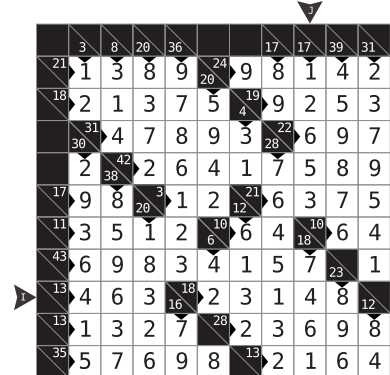

Magnets
(Čedomir Milanović)

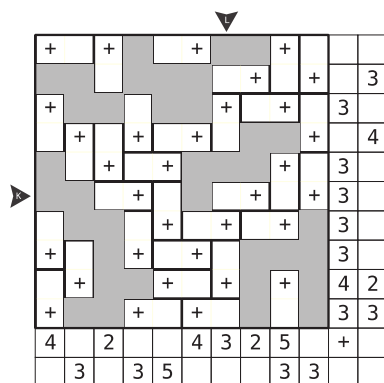

Round 2: Deja Vu

Tapa
(Priyam Bhushan)

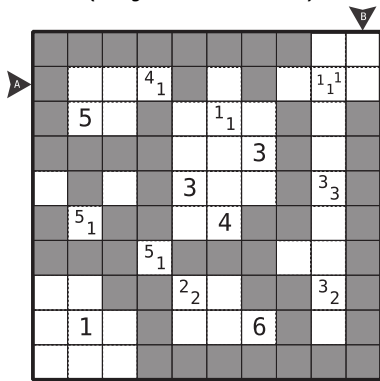

Spiral Galaxies
(Rakesh Rai)

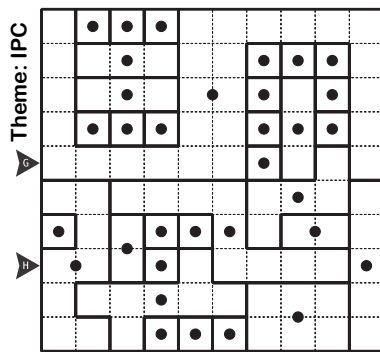

Maxi Loop
(Priyam Bhushan)

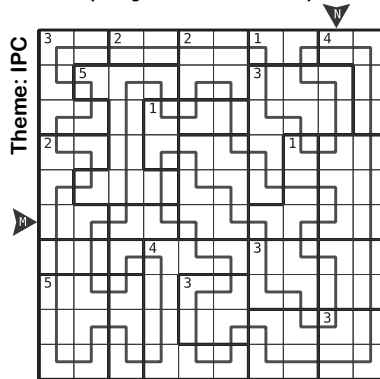

Araf
(Ivan Koswara)

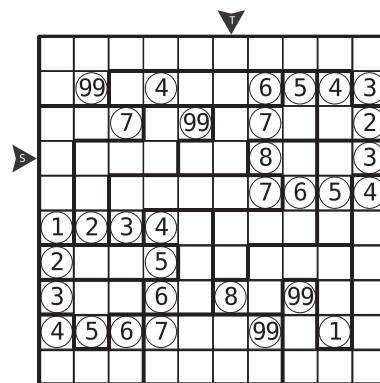

Masyu
(Ivan Koswara)

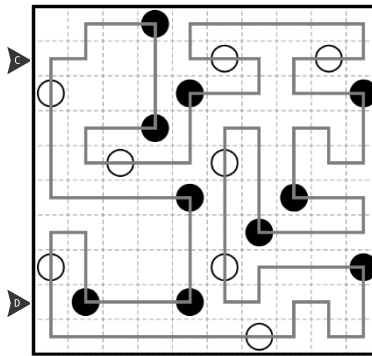

LITS
(Čedomir Milanović)

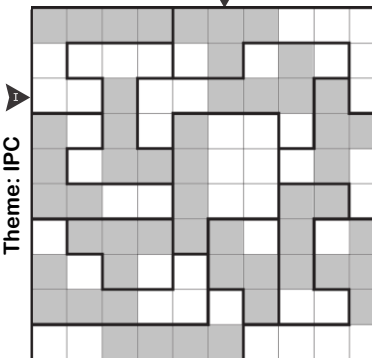

Compass
(Walker Anderson)

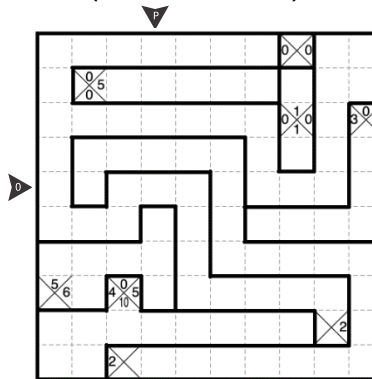

Cave
(Walker Anderson)

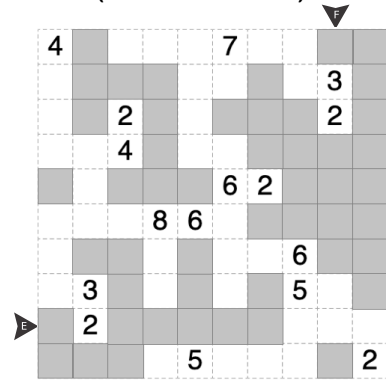

Fillomino
(Ivan Koswara)

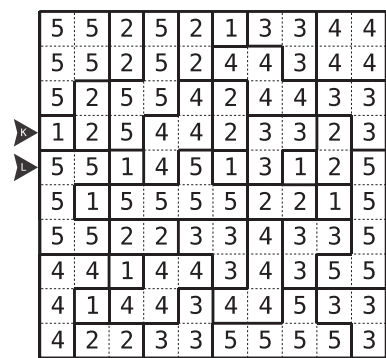

Statue Park
(Walker Anderson)

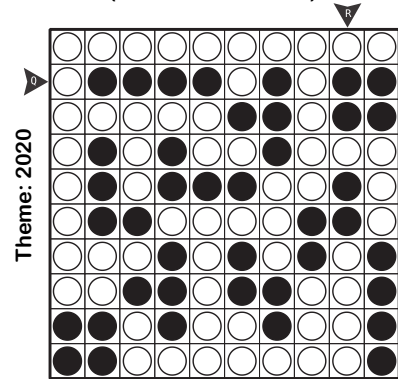

Round 3: Think Different

Castle Wall
(Ivan Koswara)

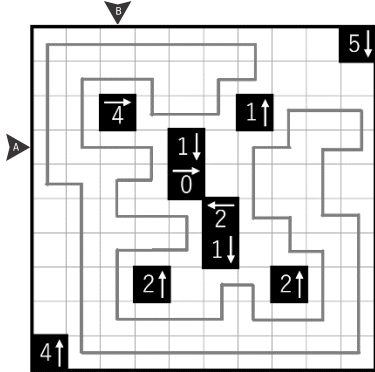

Kurotto
(Walker Anderson)

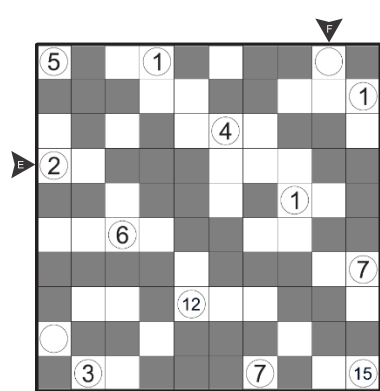

Top Heavy
(Čedomir Milanović)

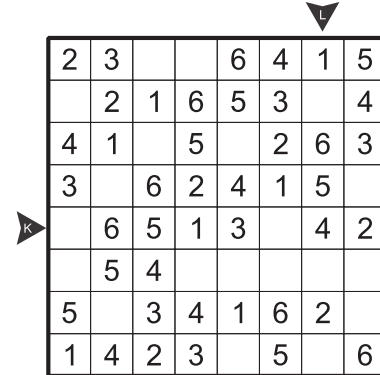

Aquarium
(Čedomir Milanović)

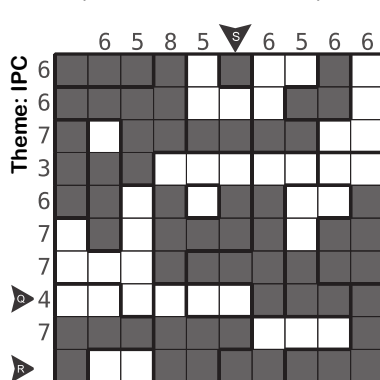

Theme: IPC

Sukoro
(Walker Anderson)

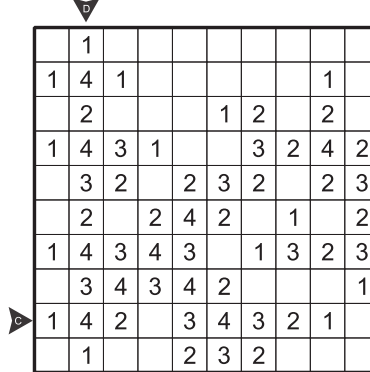

Doppelblock
(Ivan Koswara)

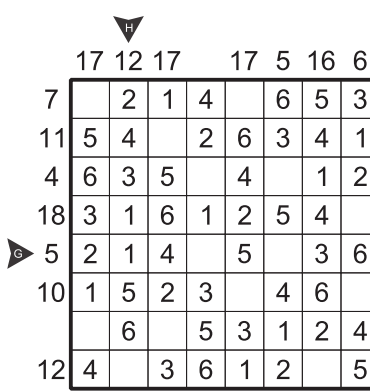

Domino Search
(Čedomir Milanović)

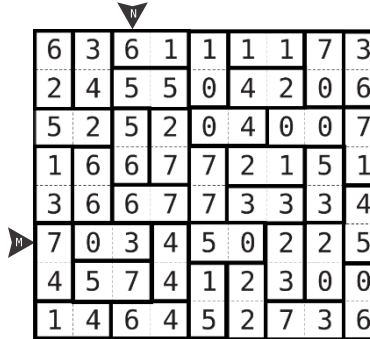

Products (Off by one)
(Rakesh Rai)

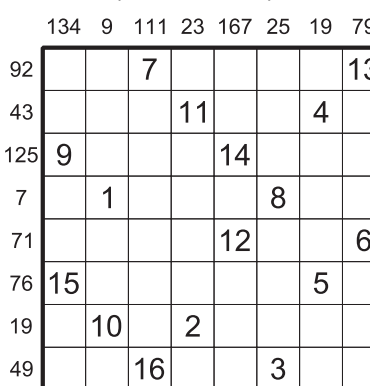

Decryption
(Nikola Zivanovic)

Theme: India, LMI

A	D	E	I	L	M	N	P	U	Z
7	0	9	3	6	2	4	5	8	1

58+11=69
3=40-37
6=2x3

Double Choco
(Walker Anderson)

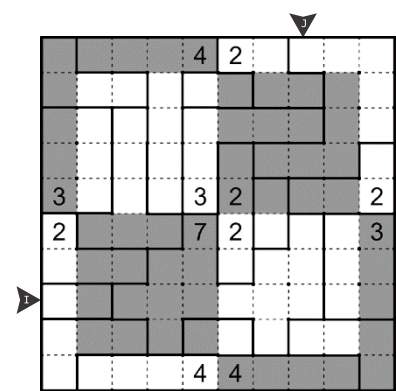

Fuzuli
(Ivan Koswara)

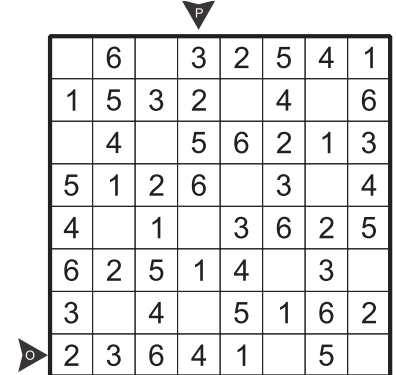

Round 4: Smart Casuals

Mark My Puzzles
(Tawan Sunathvanichkul)

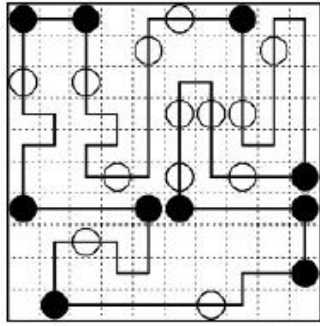

CORRECT
INCORRECT

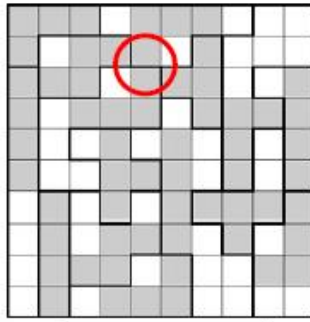

CORRECT
INCORRECT

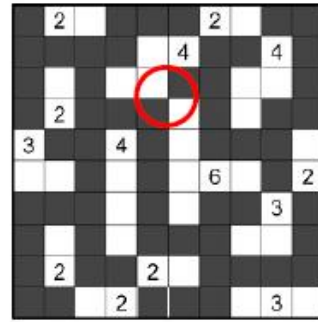

CORRECT
INCORRECT

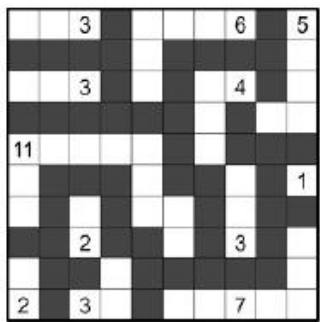

CORRECT
INCORRECT

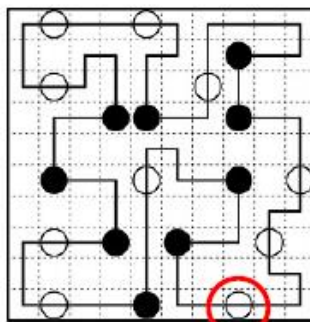

CORRECT
INCORRECT

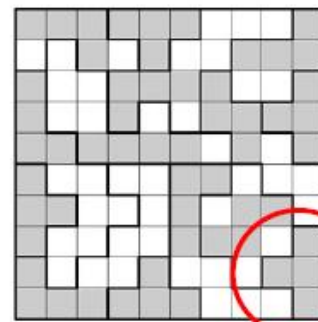

CORRECT
INCORRECT



CORRECT
INCORRECT

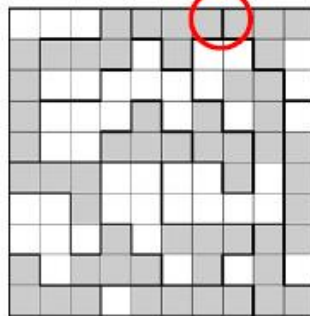

CORRECT
INCORRECT

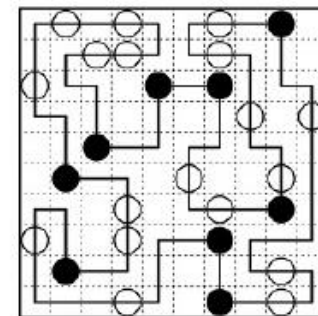

CORRECT
INCORRECT

Tom Tom
(Walker Anderson)

	2	5	4	1 ⁸	3	1
⁴	4	3	2 ⁵	1	6	2
	1	6	3	5	2	4
^A	1 ³	4	1	2	5	1 ⁸
	5	2	2 ⁶	4	1	3
^B	6	1	2	3	9 ⁴	5

Banners
(Tawan Sunathvanichkul)

- ART = 5
- CAR = 2
- CAT = 8
- COT = 7
- RAT = 9
- TAM = 3
- TIC = 1
- TIM = 4
- TOM = 6

Letter Weights
(Ivan Koswara)

A	D	E	I	N	T
3	2	1	4	5	6

Round 4: Smart Casuals

Three Steps
(Tawan Sunathvanichkul)

2E	5E	2W	3S	2E	5SW	☠	3E	5W	3S	3W
1S	2S	☠	2W	4W	4S	1N	1NW	6S	4SW	1N
☠	6E	5S	1N	4S	☠	5S	3SW	2N	3W	3S
3NE	4SE	1N	2SE	3SW	3W	3E	☠	3NW	☠	1NW
4E	2N	☠	2E	3N	4SE	1NE	4NW	2NE	1NE	1N
1N	5SE	1NW	2E	3NE	☠	2E	3SE	3NW	4N	5W
2E	☠	3E	4S	2SE	1N	4E	2W	3N	4NW	1S
3NE	3S	1NE	3SW	2SW	3SE	1E	1SE	☠	4NW	1W
2SE	☠	5E	3N	2NE	☠	1S	2W	3W	4N	☠
1NE	1E	1NW	2N	1N	4N	4NW	3W	☠	4W	3W
3N	4NE	2NW	2E	4W	1NW	2NE	1E	2N	3NW	2N

Alternate solution: 1E, 1SE, 3NW

Meteor Shower
(Tawan Sunathvanichkul)

A	C	O	A	N	I	O	G	M	I	E	L	A
M	X	R	O	V	U	R	A	O	C	N	D	P
Q	E	A	X	O	R	S	O	N	O	H	I	
O	L	N	R	S	O	R	E	P	O	S	R	N
P	F	O	D	A	R	J	A	S	I	M	U	P
V	A	R	U	S	L	D	E	M	G	N	H	O
O	G	A	R	I	A	G	T	M	E	A	C	E
I	C	S	A	U	S	L	E	O	N	M	N	I
T	E	V	T	S	E	N	R	I	V	P	E	X
M	T	N	A	C	A	P	D	M	O	U	S	I
R	A	Q	U	R	O	G	I	U	S	S	A	
A	S	G	Y	P	N	S	S	P	A	G		
M	U	Y	U	S	A	C	U	C	A	O	E	T

Theme: Constellations

Tote Bag
(Tawan Sunathvanichkul)

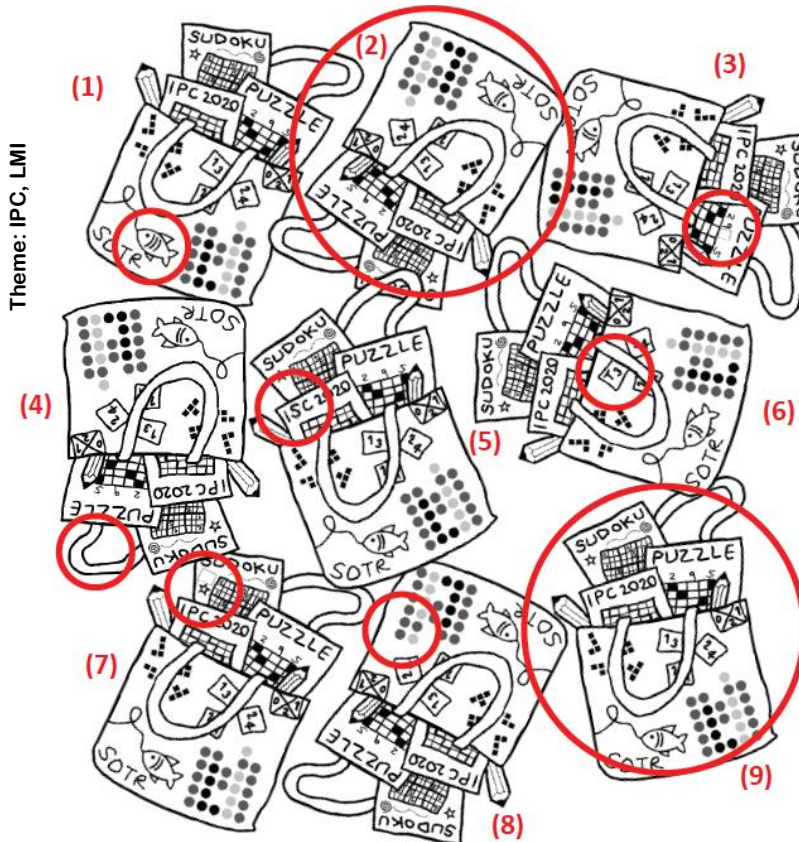

Theme: IPC, LMI

Arithmetic Square
(Čedomir Milanović)

$$\begin{array}{r}
 \boxed{2} + \boxed{5} - \boxed{1} = 6 \\
 + \quad + \quad + \\
 \boxed{9} - \boxed{7} \times \boxed{6} = 12 \\
 + \quad + \quad + \\
 \boxed{4} \times \boxed{3} + \boxed{8} = 20 \\
 = \quad = \quad = \\
 15 \quad 15 \quad 15
 \end{array}$$

Curve Data
(Rakesh Rai)

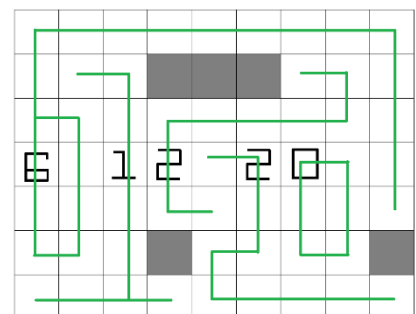

(This was themed around the original date of IPC finals)

Theme: 6-12-20

Round 4: Smart Casuals

Numerical Jigsaw 1
(Tawan Sunathvanichkul)

C	5	=	5	+	0
	2	=	1	+	1
	9	-	1	=	8
D	2	+	6	=	8

Numerical Jigsaw 2
(Tawan Sunathvanichkul)

E	6	+	5	=	1	1
	1	8	÷	2	=	9
	8	=	1	0	-	2
F	1	2	=	6	×	2

IPC Criss Cross
(Tawan Sunathvanichkul)

Theme: IPC

Round 5: Good Neighbours

1. Railroad Tracks - Masyu (Craig Kasper)

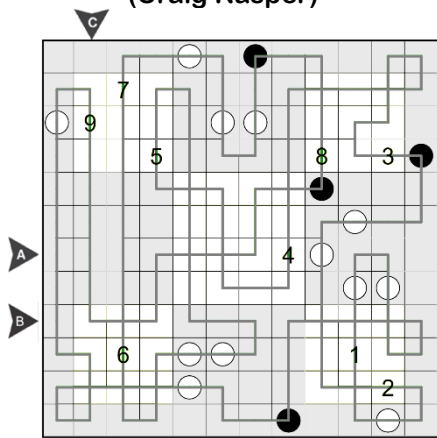

2. Railroad Tracks - Masyu (Craig Kasper)

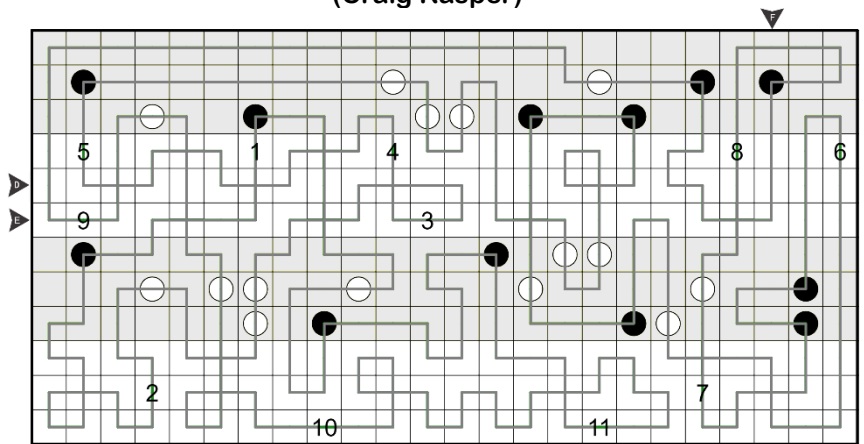

3. Ayeheya – Yajisan Kazusan (Craig Kasper)

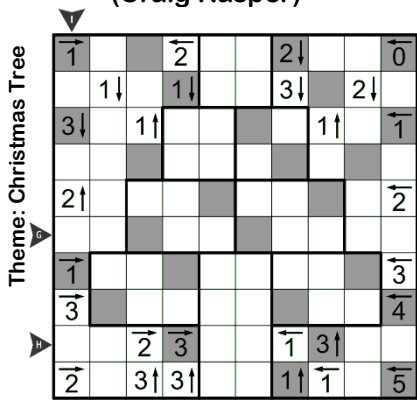

4. Ayeheya – Yajisan Kazusan (Craig Kasper)

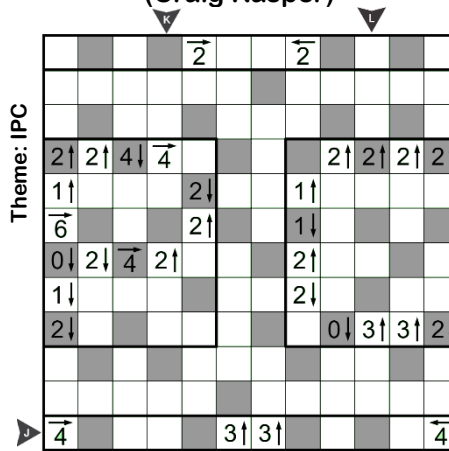

5. Tapa – Nurikabe (Craig Kasper)

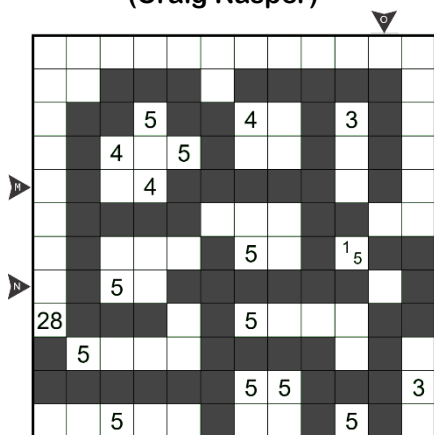

6. Tapa – Nurikabe (Craig Kasper)

