

About the authors

All 5 puzzles under "section A" are by Deb Mohanty
 Remaining 30 puzzles are by Prasanna Seshadri

A1 – Split Rectangles

14 points

Pair the figures to form rectangles. Some figures may be rotated and/or reflected. The resulting rectangles may be of different dimensions.

Split Rectangles

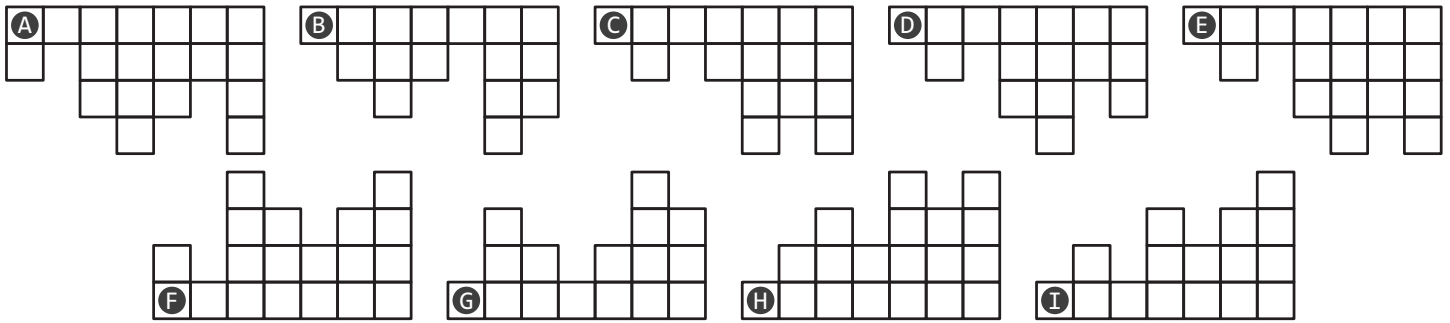

Answer : AG, BF, CE, HI

A2 – Squares Count

41 points

Pair the letters as per the number of "squares" they belong to.

Squares Count

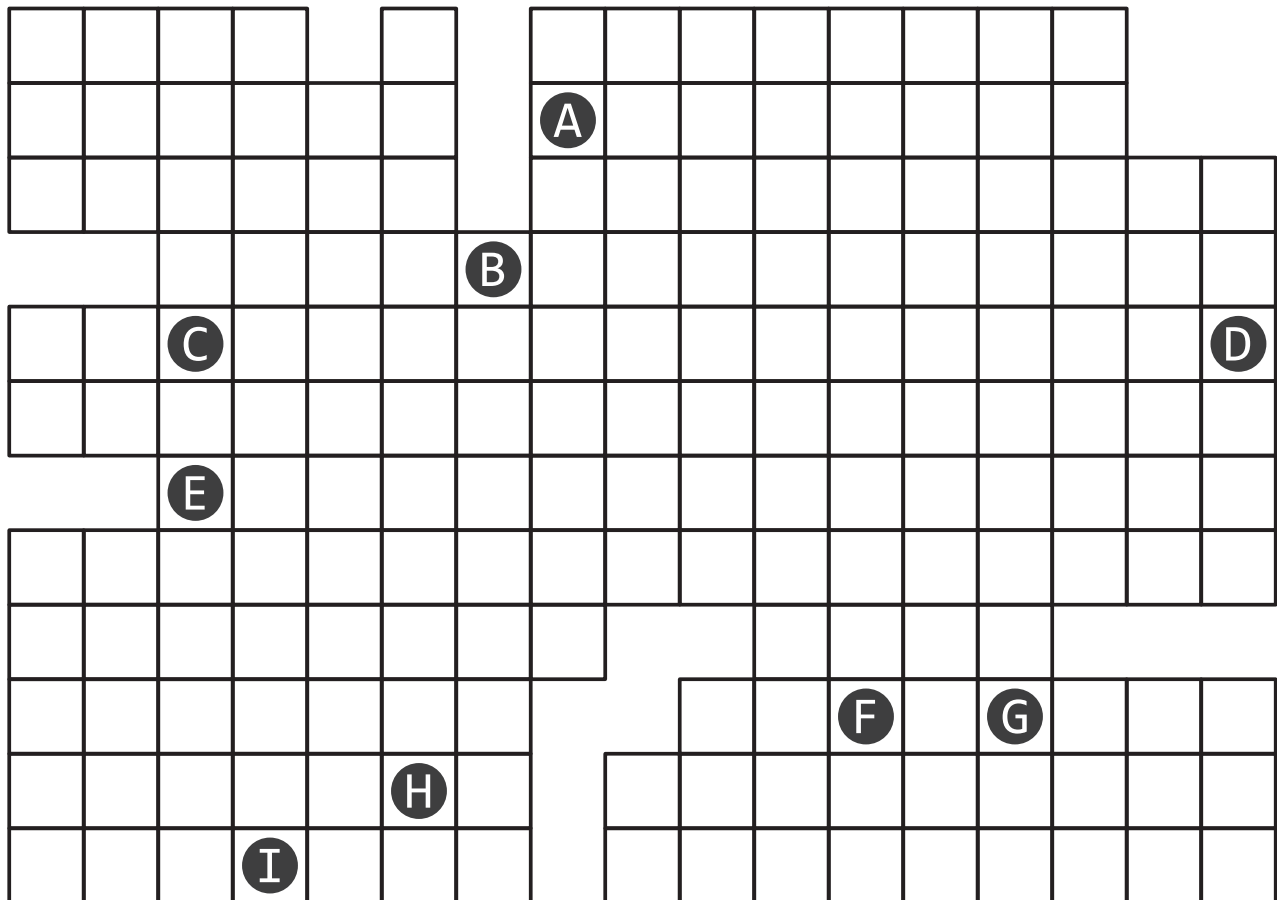

Answer Key: AC, BH, DG, EF

Pair the figures after unscrambling i.e. find pairs which have same set of elements, not necessarily in the same order.

Unscramble

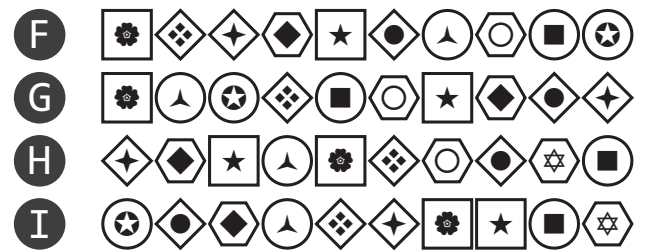
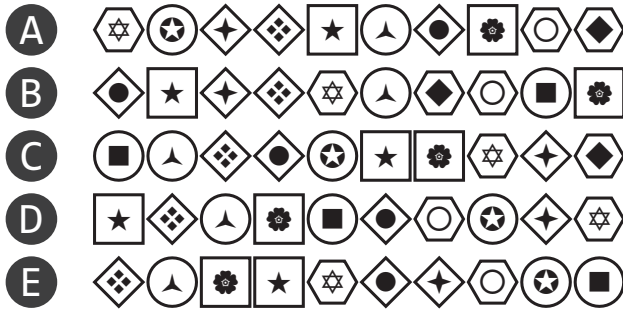

Answer Key: BH, CI, DE, FG

Pair the identical figures. Some of them may be rotated, but not reflected.

Identical pairs

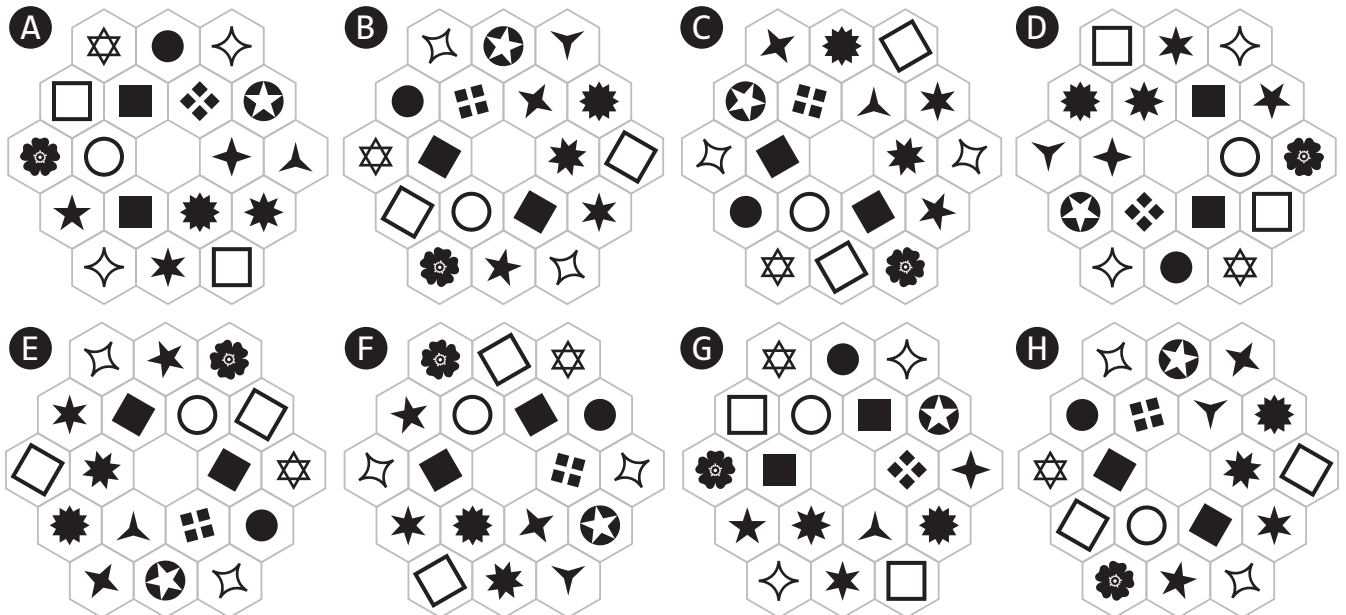

Answer Key: AF, BD, CG, EH

This is based on a puzzle type appearing elsewhere in this booklet.
Deduce the type, and match pairs of grids having the same solution.

Surprise

A

B

C

D

E

F

G

H

Answer Key: AH, BE, CF, DG

B1, B2 – As Easy As ABC

13 + 31 points

N I N T H

	I	N	T	H
N	T	H		I
H		T	I	N
T	N	I	H	
I	H		N	T

I H I

A U G U S T

	U	G		S	T	A
S	S	T		A	G	U
A	A	T		U		S
T	T	A	S	G	U	
	U		A	T	G	S
	S	G		A	T	U
G	G		U	S		A

G U S T

B3 – As Easy As ABC [Numbers]

45 points

T1 W5 E1 N5 T1 Y5

T	Y	E	W		N
N	E	W	Y	T	
W	N	Y		E	T
	T	N	E	Y	W
Y	W		T	N	E
E		T	N	W	Y

C1, C2 – Kakuro

39 + 80 points

	15	41	7		16	40	17
20	9	7	4	12	9	1	2
28	5	2	3	1	7	4	6
5	1	4			15	6	9
	6	5	1	12	3	9	13
12	3	9	13		14	7	1
29	1	6	4	2	8	5	3
19	2	8	9	23	6	8	9

	14	26	5			45	6	21	11
12	3	8	1	45		12	4	1	3
28	8	9	4	7	32	9	8	5	7
9	2	7	15	9	1	3	2	14	9
10	1	2	4	3		19	7	9	2
			14	8	6		4	3	1
			6	1	5	8	1	5	2
26	9	7	2	8	15	20	7	6	4
5	4	1	16	4	9	2	1	9	8
16	3	2	4	1	6		28	9	8
22	8	3	9	2				21	7

	45	28	11	6	26	5	32	40	
30	7		6		8		9		
32		7		5	9	3		8	
14	3		1		2		8		
23		4		1	7	2		9	
13	9		4			4	4	1	
9	4	5			9	3	1		5
6	6			4		1		3	
14	8	6			4		3		1
14	5		9	10	13		4	4	
12		1		2		5		4	
10	1		3		4		2		
17		3		1		7		6	
37	2		6	7	9	8	5		
2		2				16	9		7

D1, D2, D3 – Statue Park

13 + 10 + 19 points

D1 Bank

D2 Bank

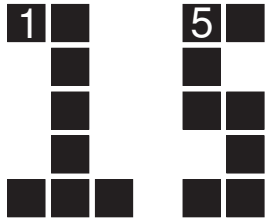
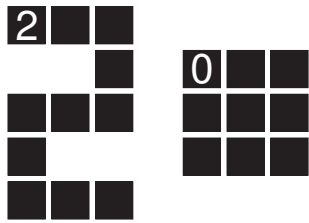

D3 Bank

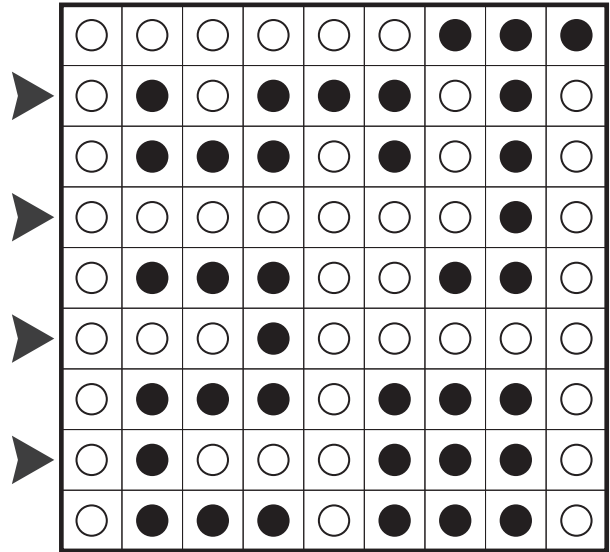

E1, E2 – Regional Star Battle

12 + 24 points

A B C D E F G H I J

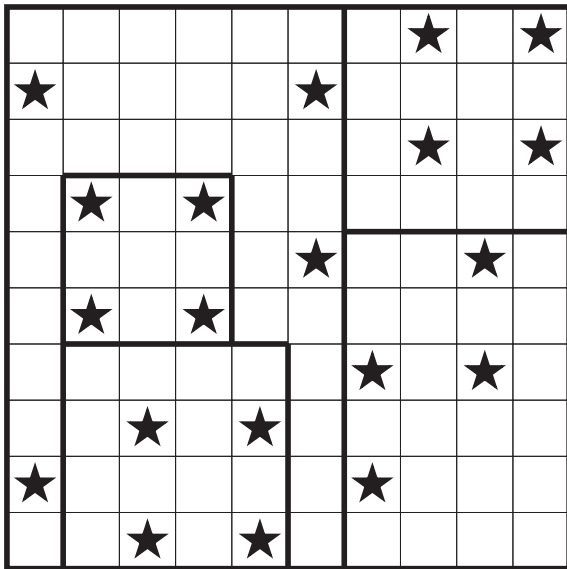

A B C D E F G H I J

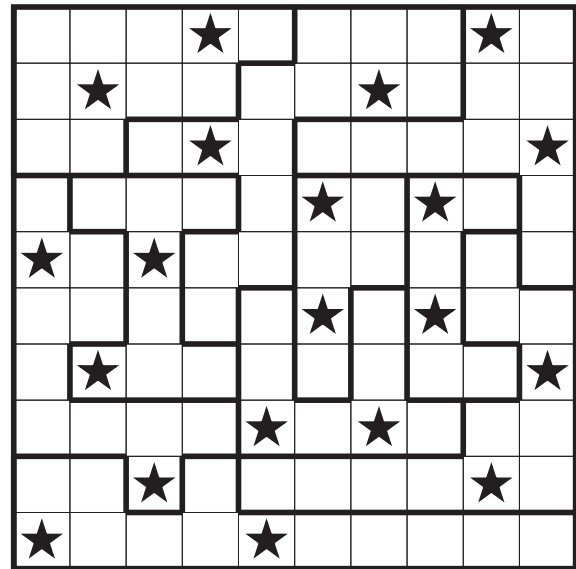

F1, F2 – Fillomino

25 + 25 points

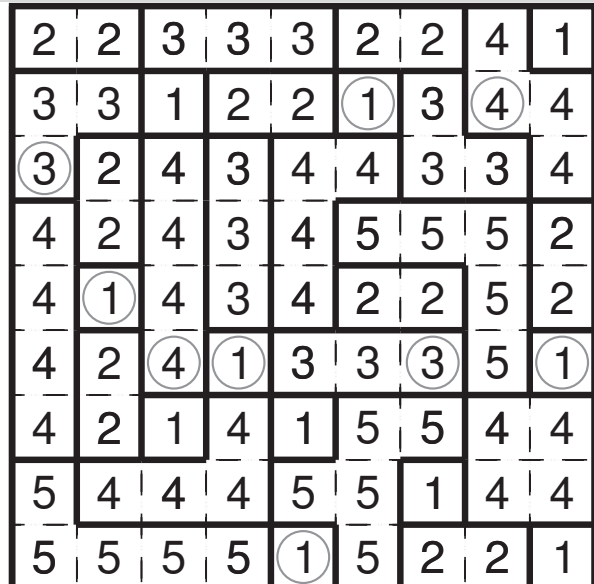
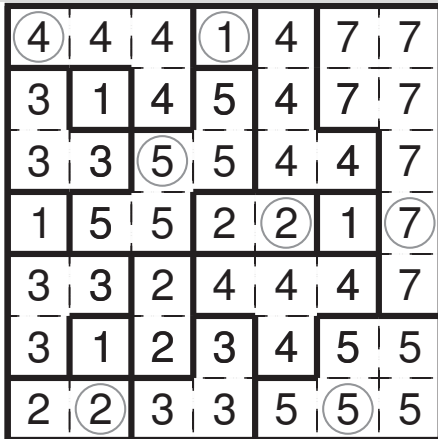

	3		3	3	7	7	7	7	7
3	3	1	3	6	6		7		7
4	1		1		6	5	5	3	③
4	4	1	6	6	6	5		3	
2	④	⑤		5		5	5	1	3
2		5	2	5	5	③		3	3
1	5	5	②	5		3	3	①	
	3	5		5	3	2	2	4	4
3	3	4	4	③	3		3		4
①		4	4		①	3	3	1	4

○ ○ ○ ○ ○ ○ ○ ○ ○ ○ ○

G1, G2 – Not Alone

26 + 36 points

▶	●	○	○	●	●	●	○	○
	○	●	●	●	○	○	○	○
	○	●	●	○	○	○	○	●
	●	○	○	○	○	●	●	●
▶	●	○	○	○	●	●	●	○
▶	○	●	●	○	○	○	●	●
▶	○	●	●	○	○	○	○	●

▶	○	●	●	●	○	○	○	○	●	●	○
	○	○	○	●	●	○	○	○	○	●	●
▶	●	○	○	○	○	●	○	○	○	●	●
	●	●	●	○	○	○	○	●	●	○	○
	●	●	●	○	○	○	○	○	○	○	○
▶	○	○	○	○	○	○	○	○	○	○	○
▶	○	○	○	○	○	○	○	○	○	○	○
▶	○	○	○	○	○	○	○	○	○	○	○
▶	○	○	○	○	○	○	○	○	○	○	○
▶	○	○	○	○	○	○	○	○	○	○	○
▶	○	○	○	○	○	○	○	○	○	○	○
▶	○	○	○	○	○	○	○	○	○	○	○
▶	○	○	○	○	○	○	○	○	○	○	○
▶	○	○	○	○	○	○	○	○	○	○	○
▶	○	○	○	○	○	○	○	○	○	○	○

H1, H2 – Tapa

8 + 24 points

			1 ₃				3
▶							
▶	1 ₃						1 ₁
	1 ₂				1 ₃		

		1 ₅					1 ₄
				6			
	6						4
			6		7		
	1 ₃						7
				7			
	5						3 ₃

THE
INDIAN
PUZZLE
CHAMPIONSHIP
IS
SET
ON
NINTH
AUGUST
2015
AT
LOGIC
MASTERS
INDIA

	2	0	1	5		P	U	Z	Z	L	E
								1 ₃		5	
	7		L		T	H	E				
		1 ₁	O					O		M	
	A	U	G	U	S	T		N		A	
1 ₃		3	I	1	E					S	
			C		T		I		5	T	1 ₁
	N						N			E	
	I	N	D	I	A		D		4	R	
	N				T		I		I	S	
	T		5				A				
C	H	A	M	P	I	O	N	S	H	I	P

I1, I2, I3 – Balance Loop

14 + 11 + 38 points

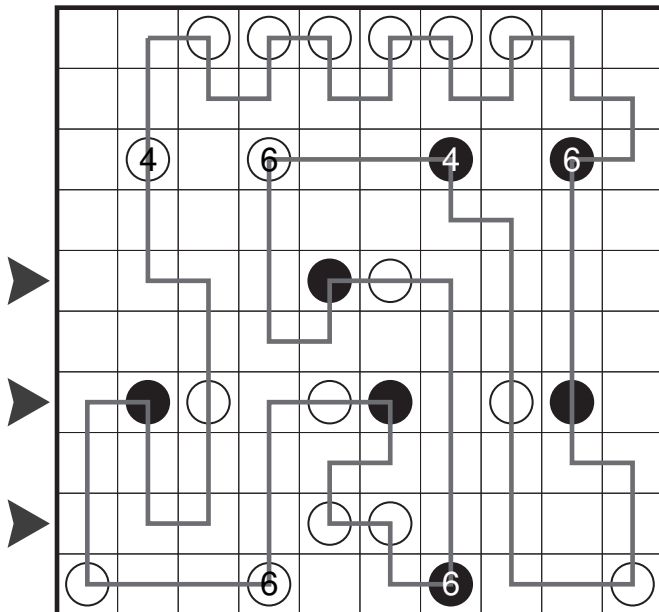
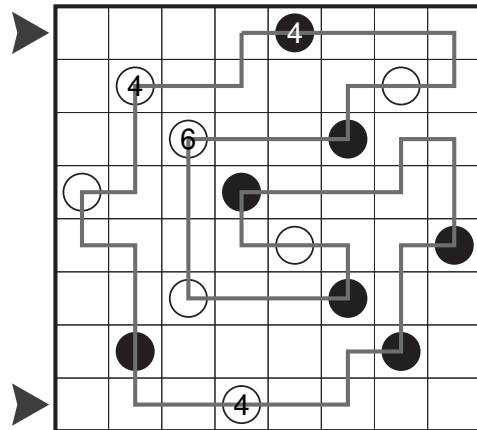
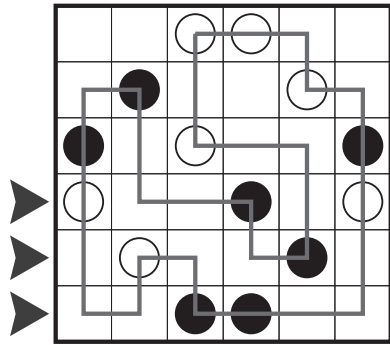

J1, J2 – Slitherlink

13 + 54 points

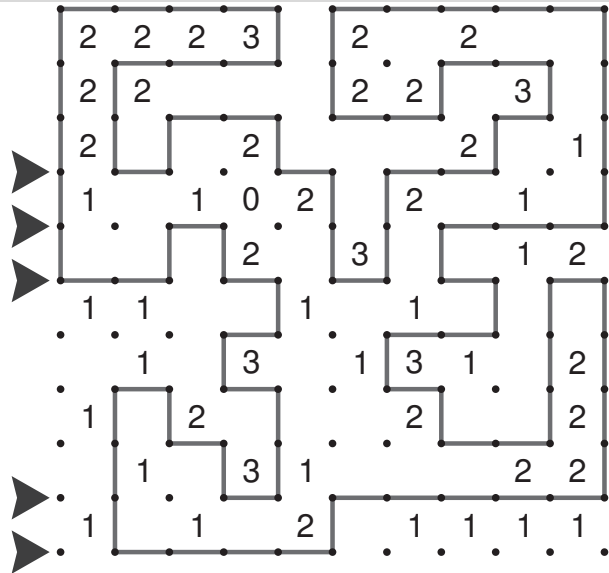
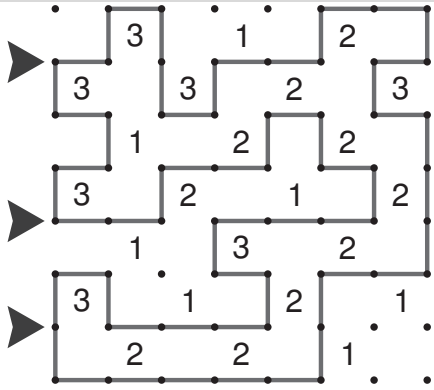

J3 – Loop the Loops

35 points

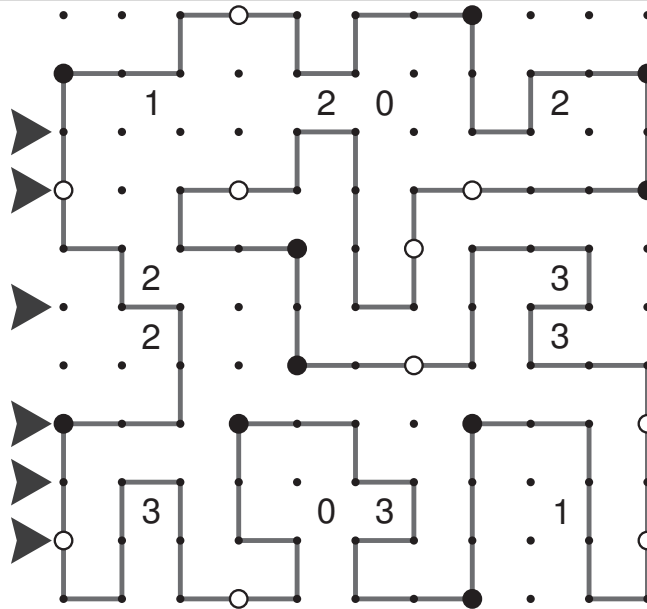

K1, K2 – Three-Point Snake

16 + 11 points

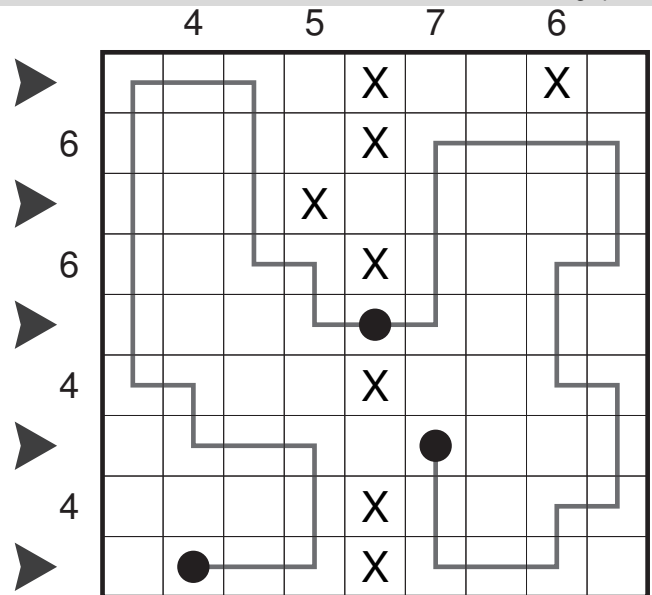
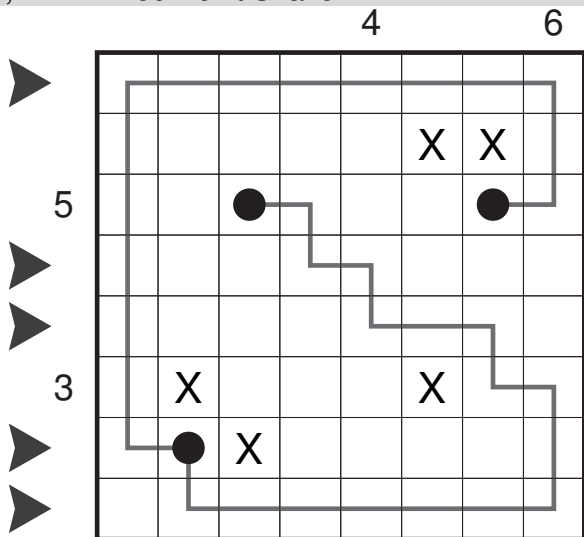

L1, L2 – LITS

12 + 16 points

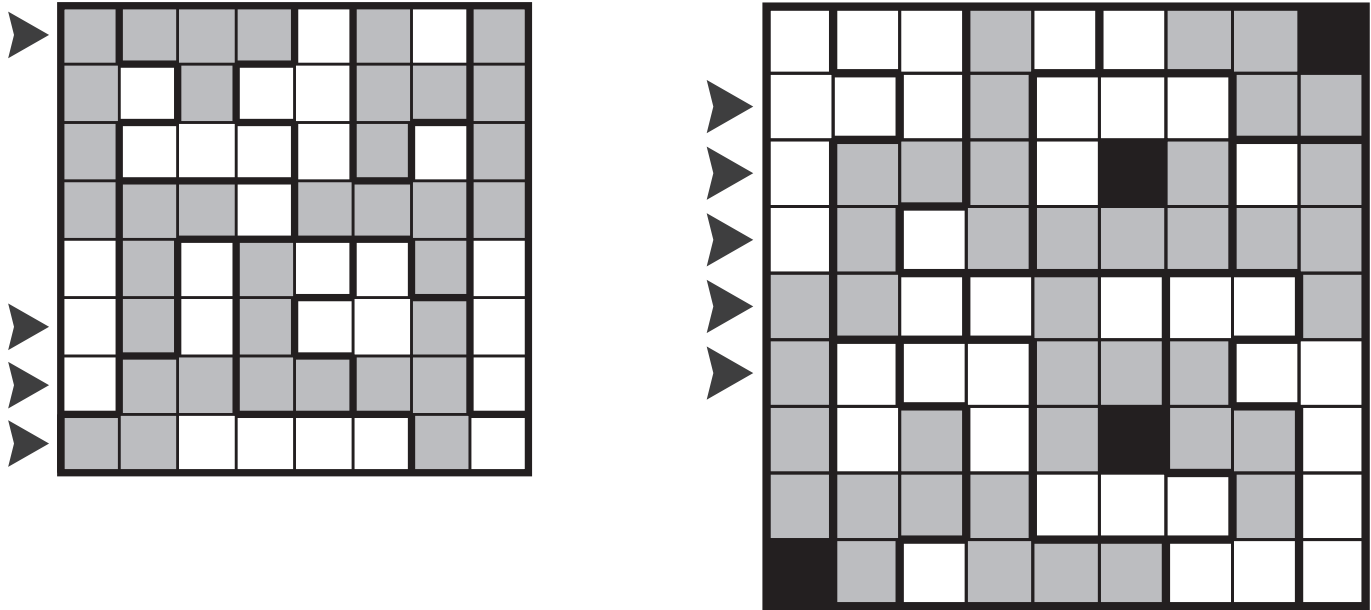

L3 – Outside LITS

9 points

