

# Solution Booklet WPC Round 1

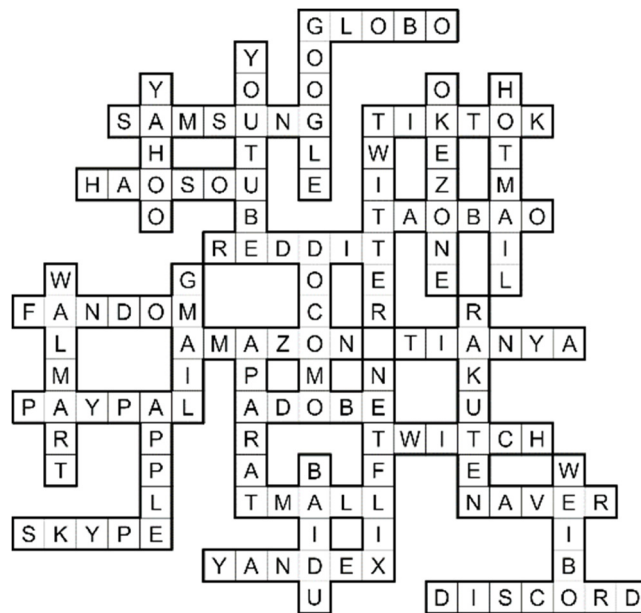

Log In – Tawan Sunathvanichkul

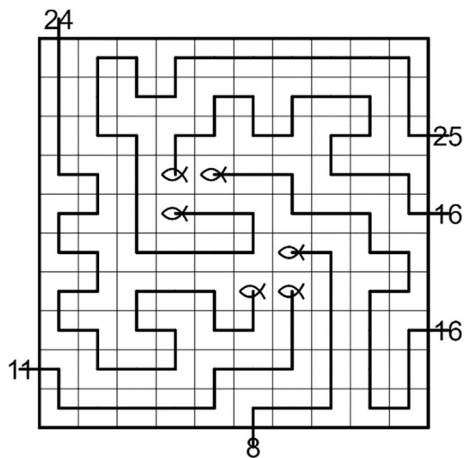

Anglers – Yanzhe Qiu

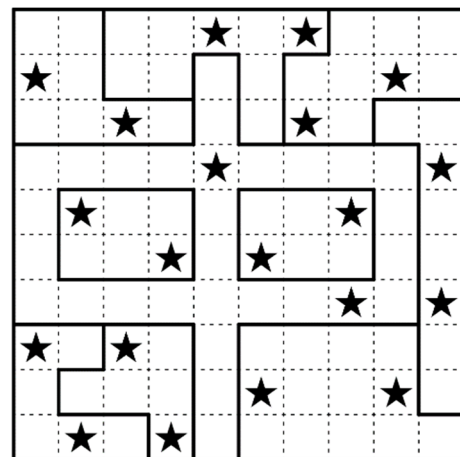

Star Battle – Chenhao Xu

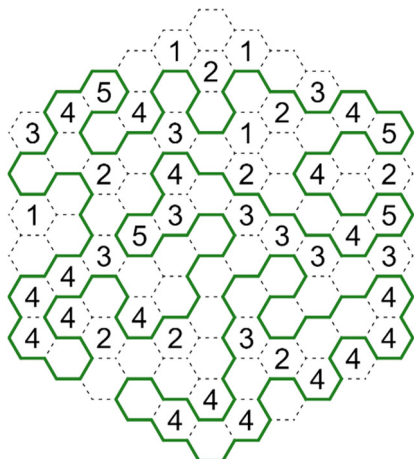

Hexa Slitherlink – Chenhao Xu

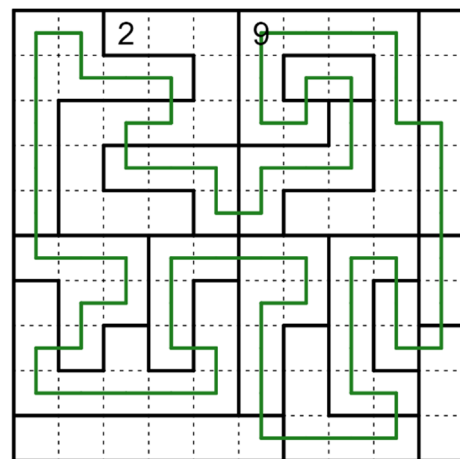

Country Road – Chenhao Xu

# Solution Booklet WPC Round 1

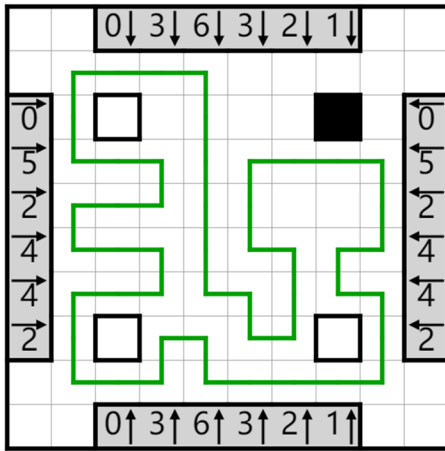

Castle Wall – Mingyi Wang

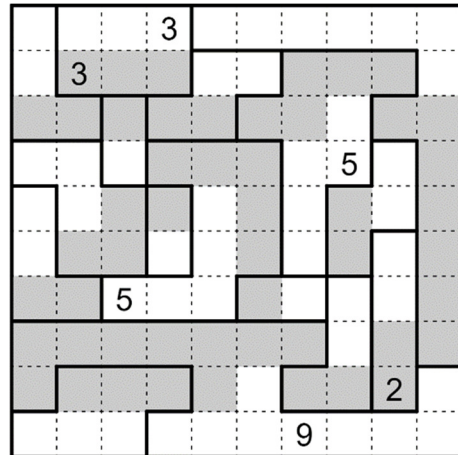

Double Choco – Chenhao Xu

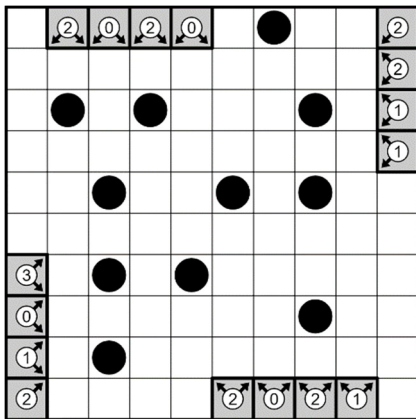

Diagonal Lighthouses 1 – Chenhao Xu

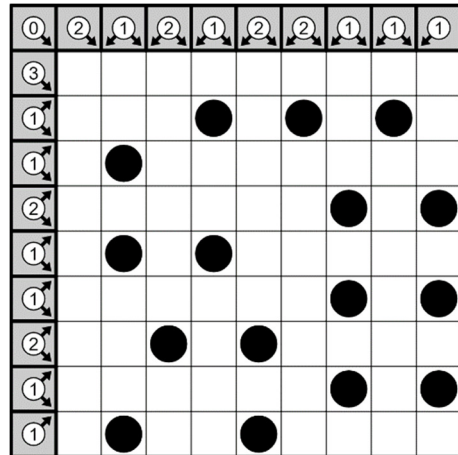

Diagonal Lighthouses 2 – Chenhao Xu

2	3	1	1	3	3	2	2	1
2	3	2	3	2	1	1	3	1
3	1	2	1	2	2	3	3	1
3	2	3	2	1	2	1	1	3
1	2	1	2	3	3	2	1	3
1	1	3	3	2	3	1	2	2
2	2	1	3	3	1	3	1	2
1	1	2	2	1	2	3	3	3
3	3	3	1	1	1	2	2	2

Neighbours – Chenhao Xu

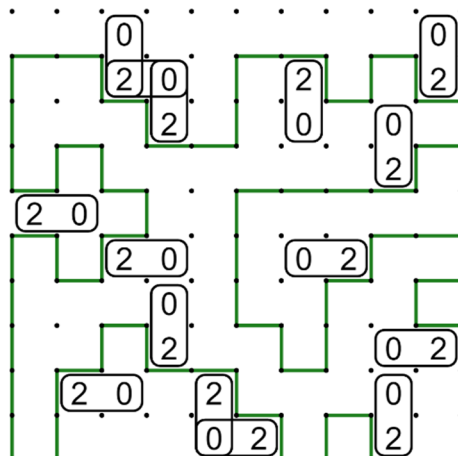

2-0 Slitherlink – Yanzhe Qiu