

Masyu - A

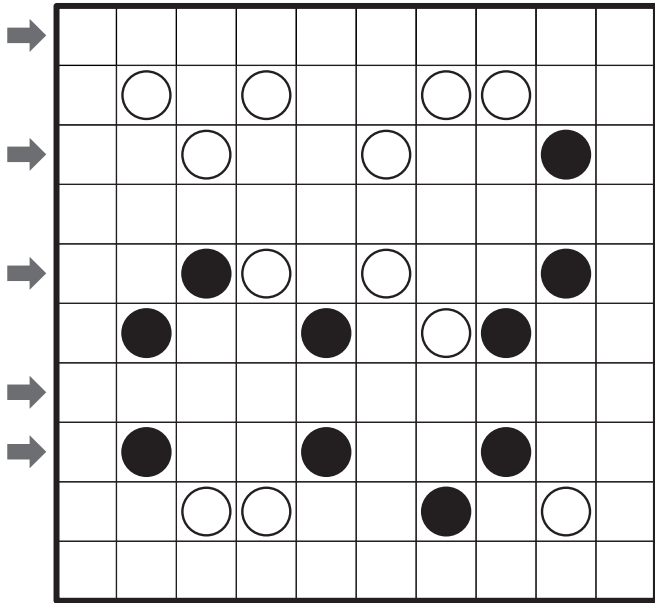

Answer

Masyu - B

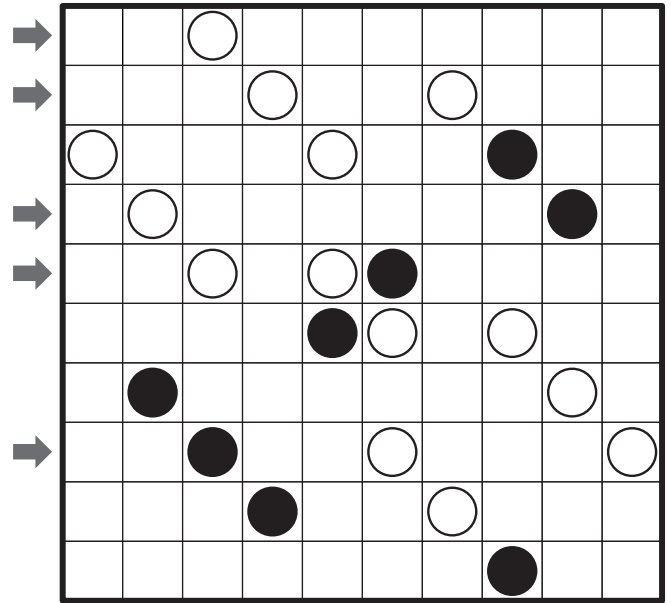

Answer

Masyu - C

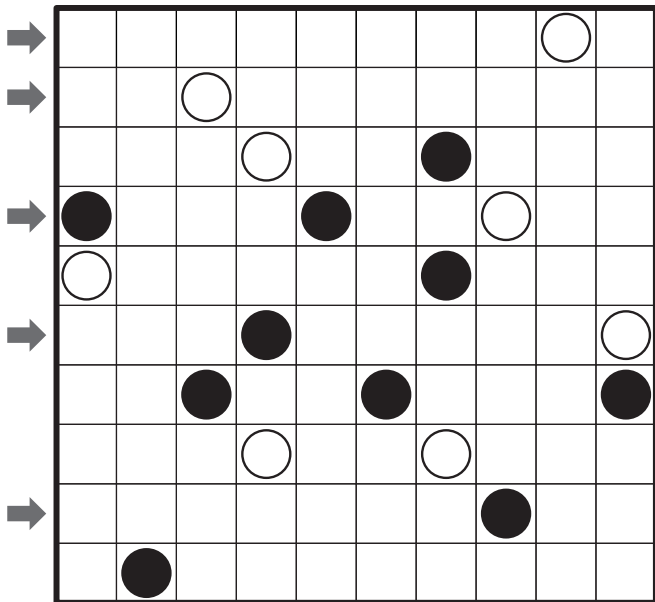

Answer

Masyu - D

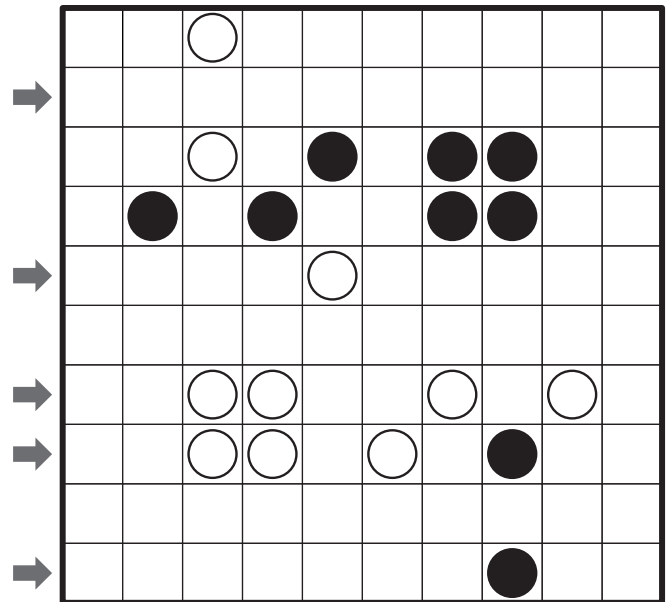

Answer

Masyu - E

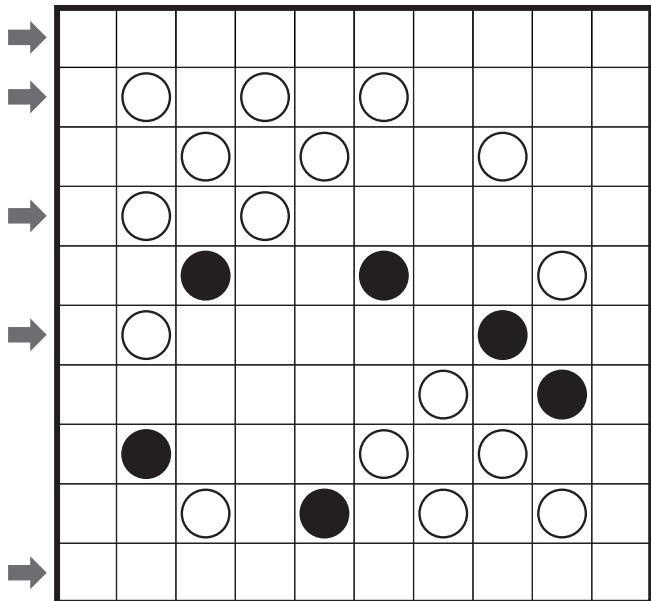

Answer

Masyu - F

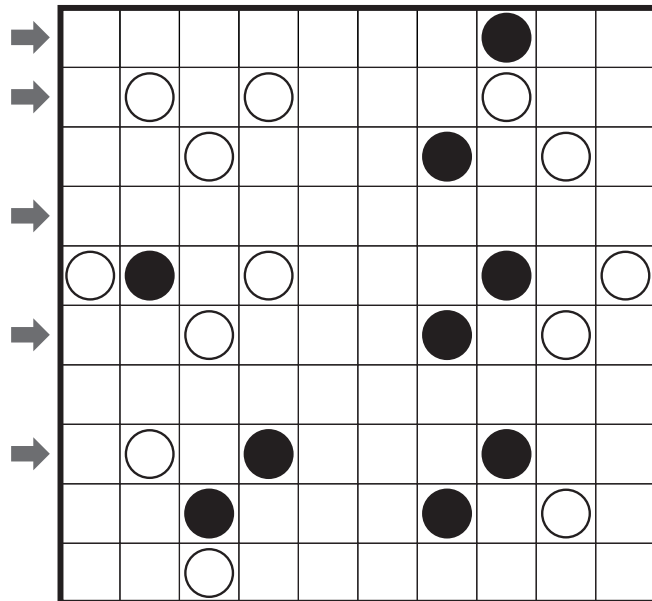

Answer

Masyu - G

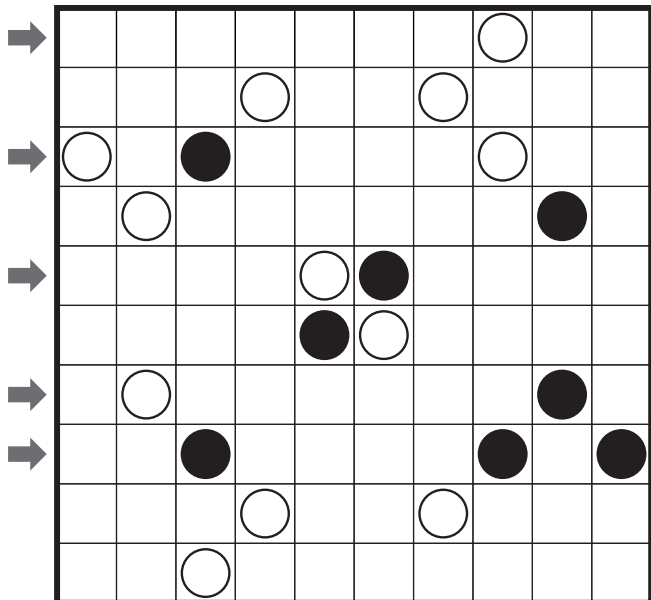

Answer

Masyu - H

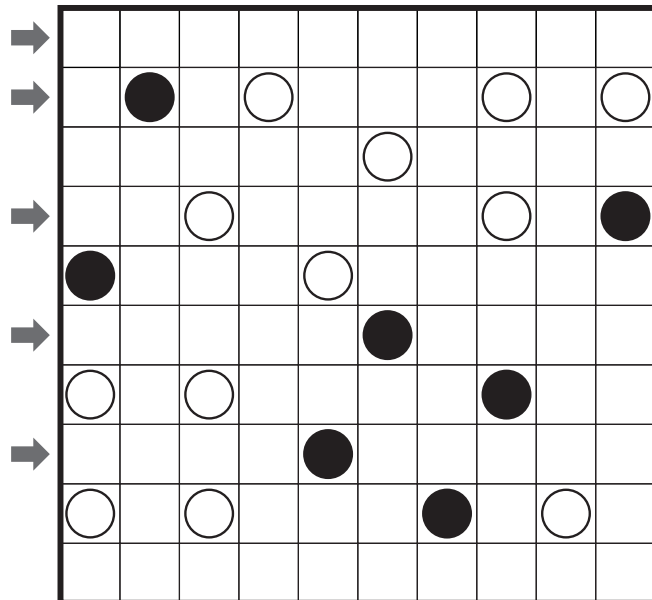

Answer

Masyu - M

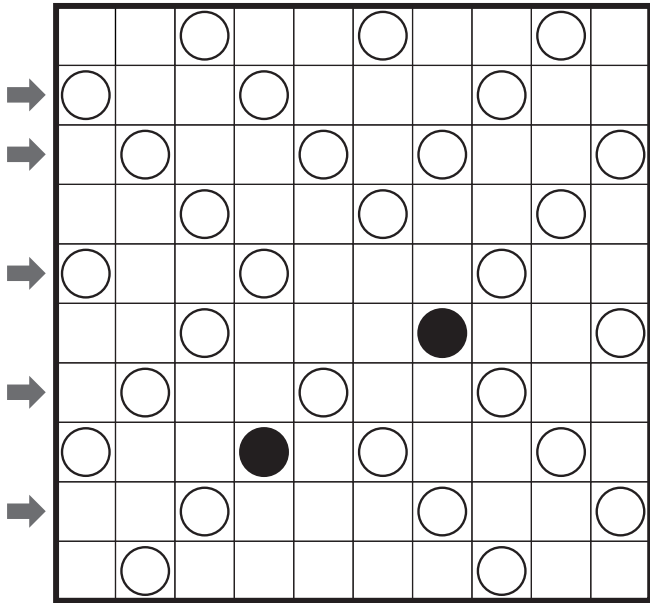

Answer

Masyu - N

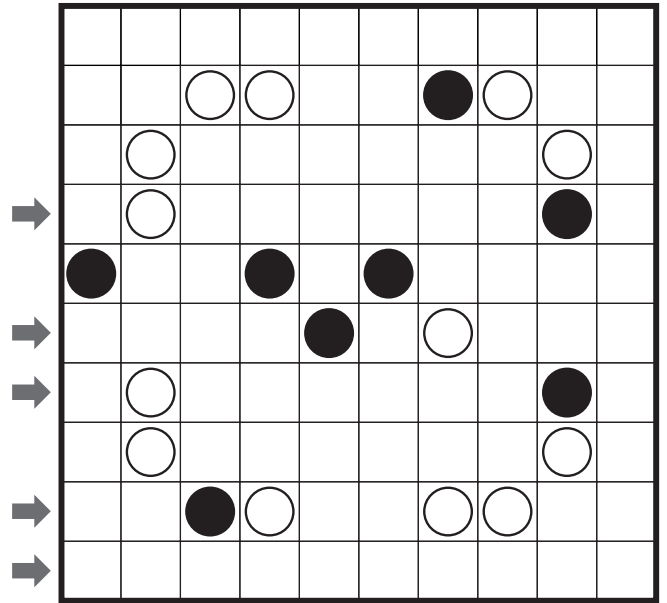

Answer

Masyu - O

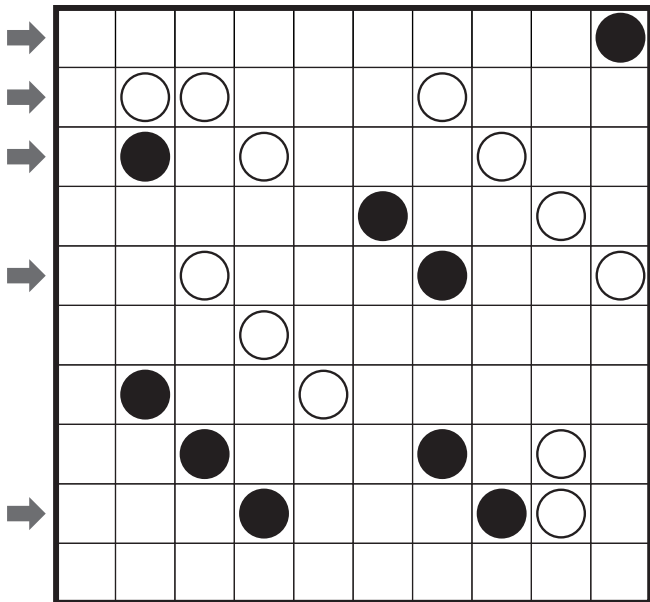

Answer

Masyu - P

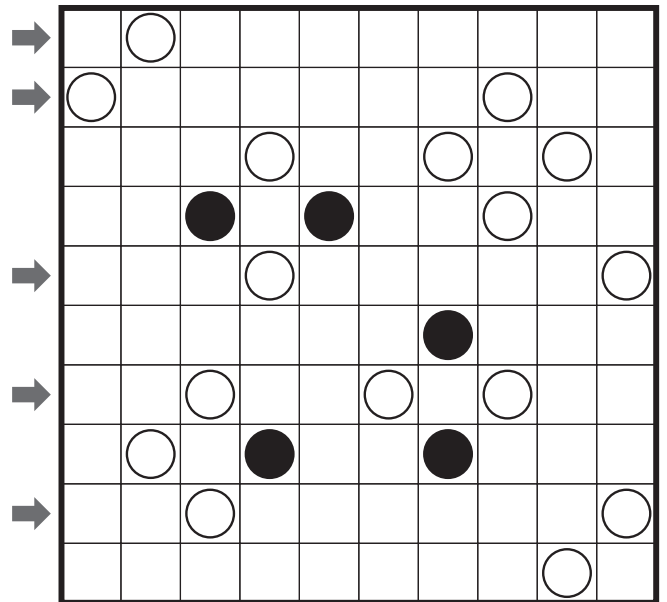

Answer

CAUTION: Given the points structure, it is best if you attempt this puzzle after solving the smaller ones.

Masyu - Q

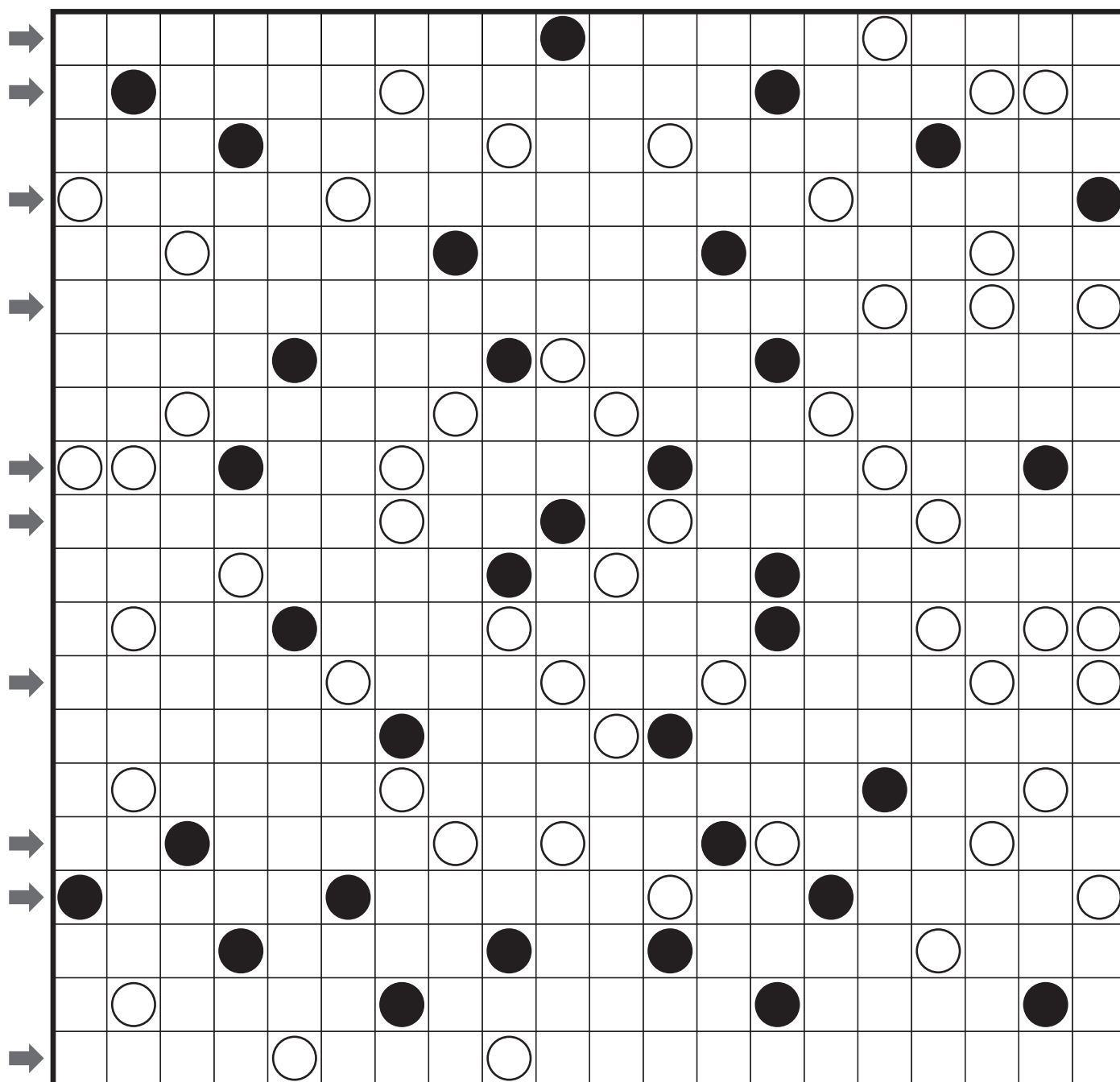

Masyu - A

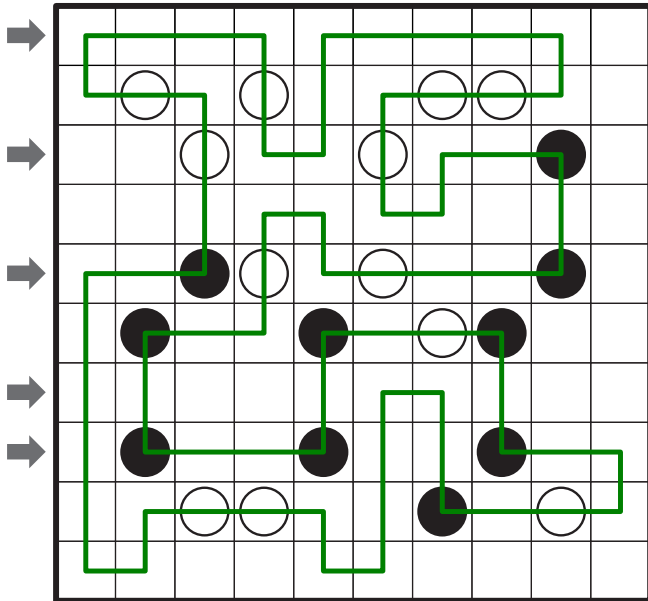

Answer - 13140

Masyu - B

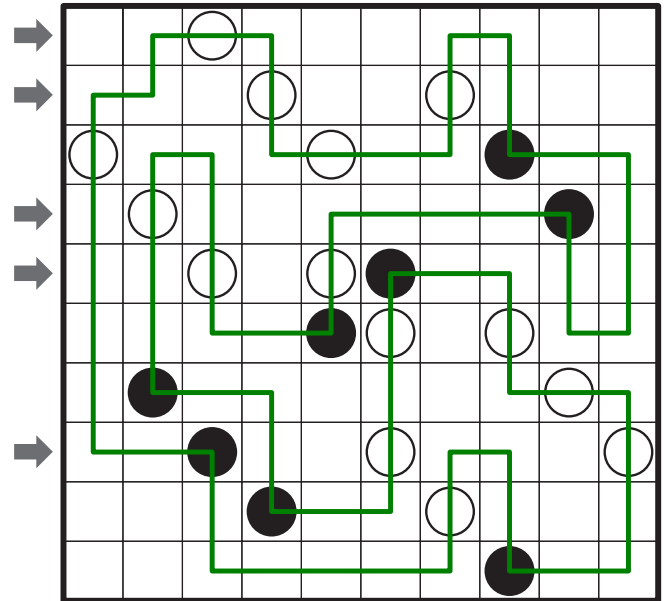

Answer - 55112

Masyu - C

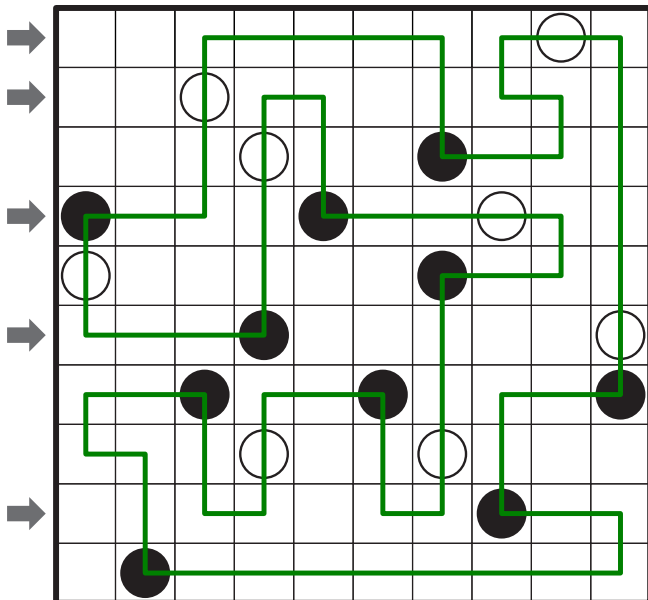

Answer - 23042

Masyu - D

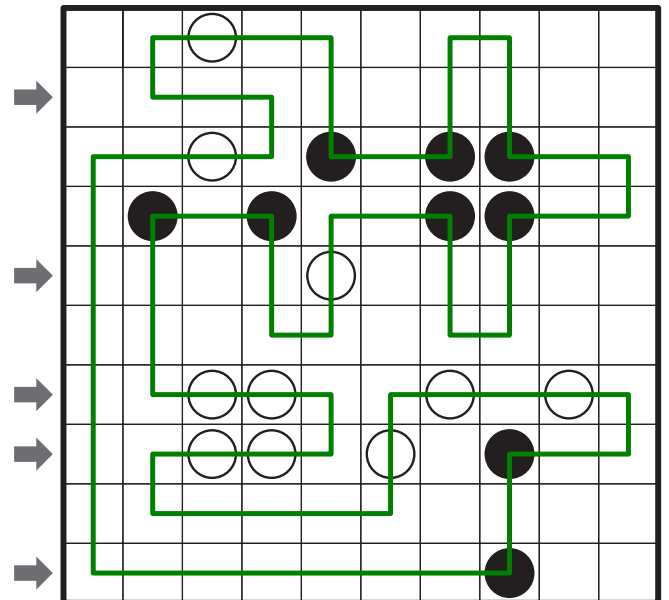

Answer - 44012

Masyu - E

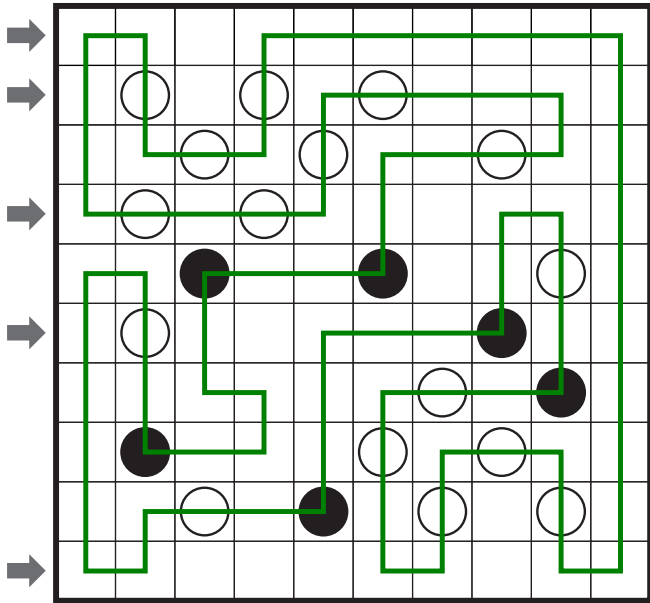

Answer - 11114

Masyu - F

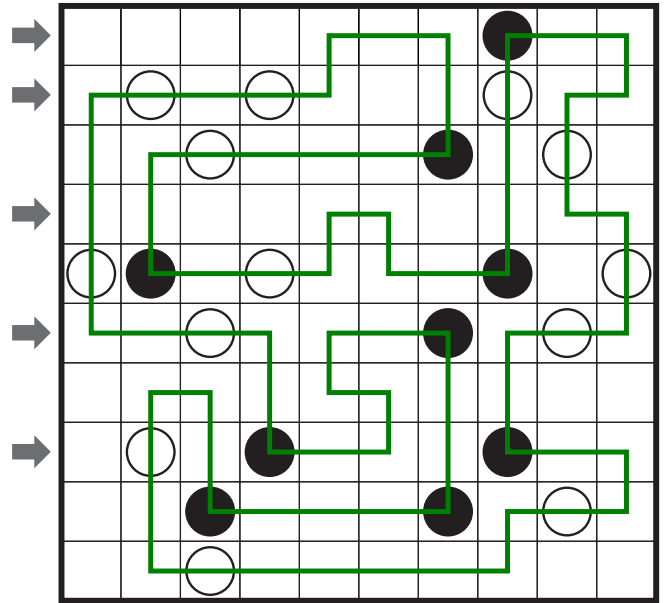

Answer - 41301

Masyu - G

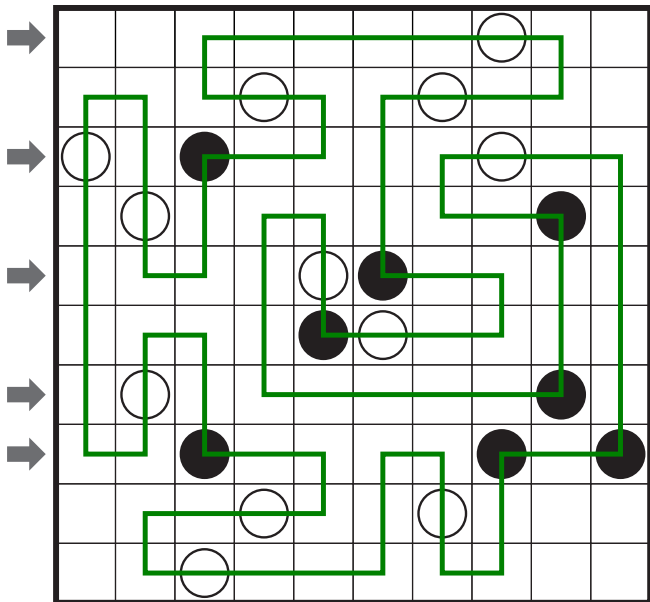

Answer - 30000

Masyu - H

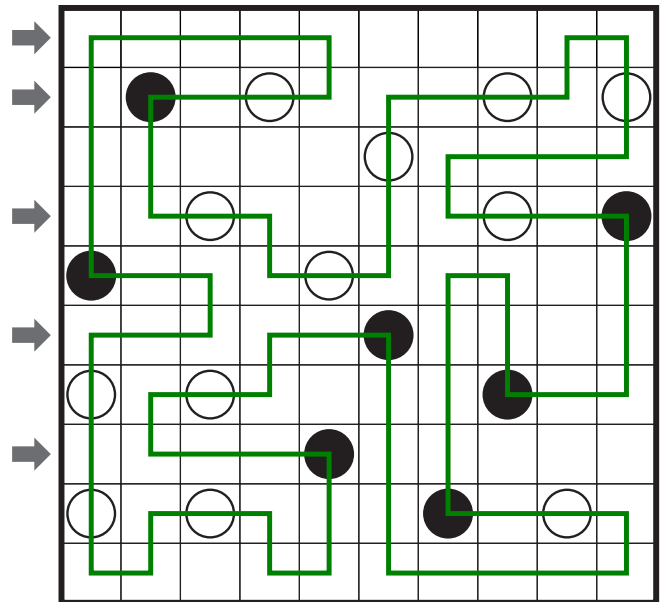

Answer - 30113

Masyu - M

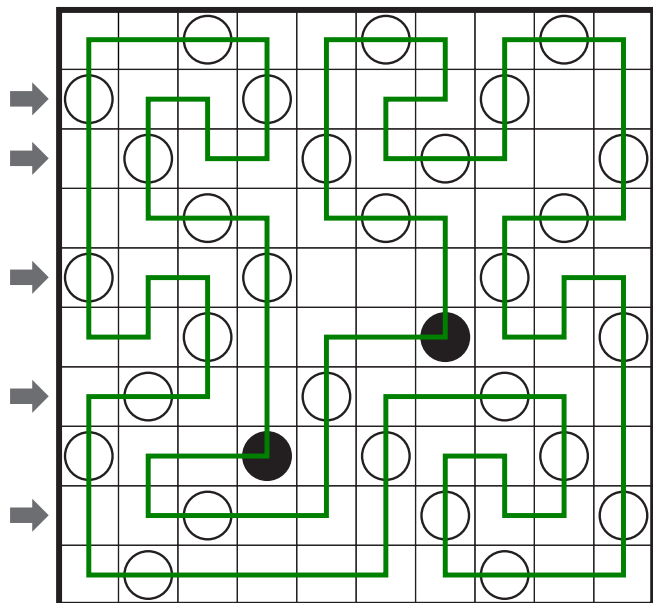

Answer - 11200

Masyu - N

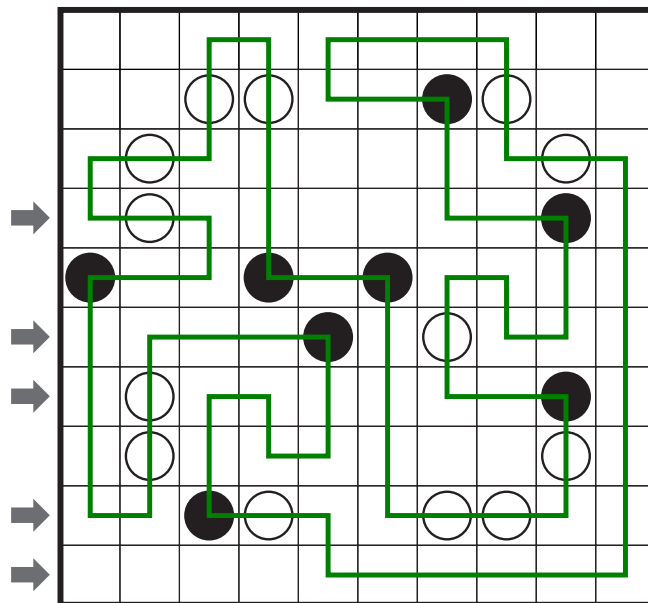

Answer - 20004

Masyu - O

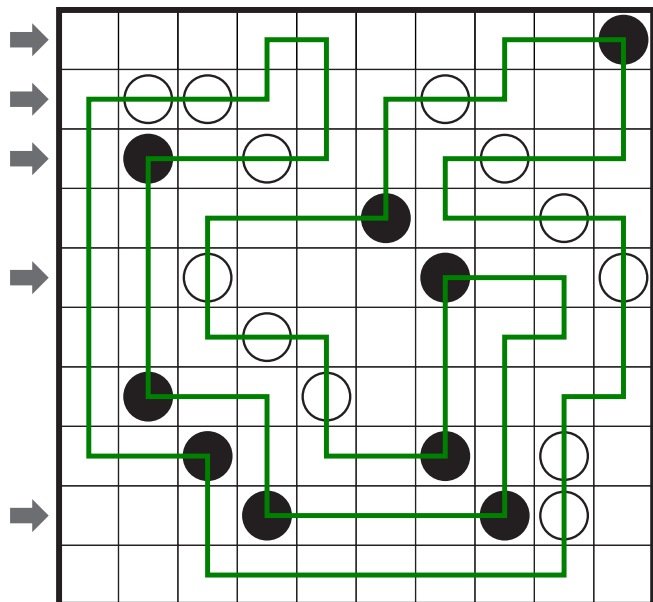

Answer - 51033

Masyu - P

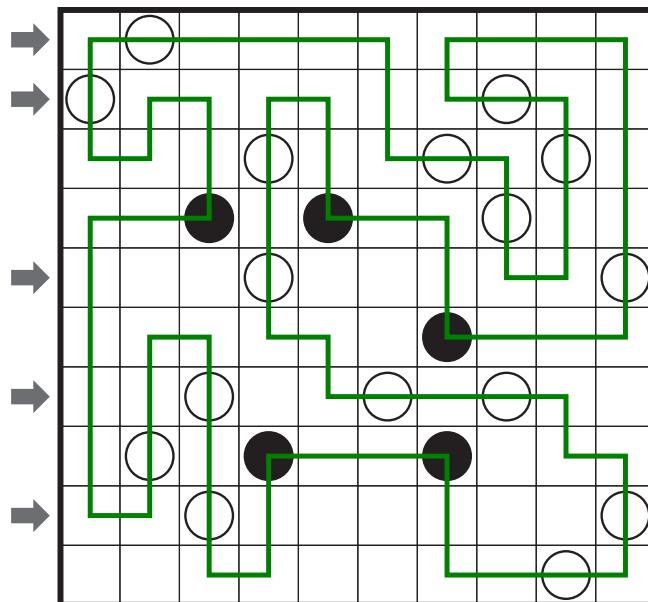

Answer - 00424

Masyu - Q

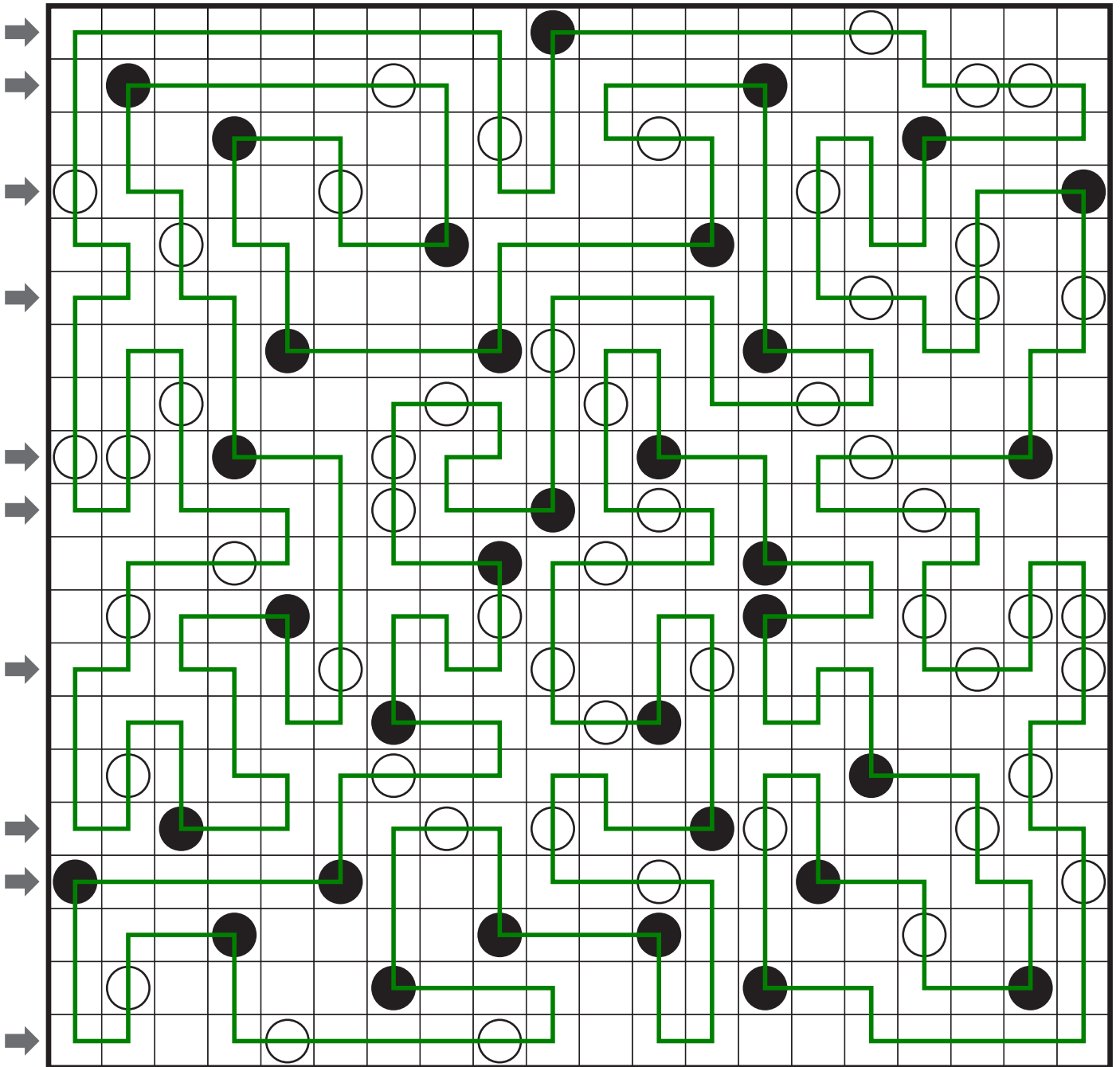

Answer - 3244121214